



## RECEIVER AND TRANSMITTER CATALOG

### 3<sup>rd</sup> Generation Rack-Mount RDMS™ Telemetry Receiver



Pg. 2

The highest performing telemetry receiver on the market is available in an elegant, compact 1U rack mount package and a new 3U touchscreen package. Configurations include one or two channels, diversity combining, contiguous tuning, spectrum display, adaptive equalizer, and decoding for SOQPSK Space Time Coded and Low Density Parity Check encoded signals.

### Compact RDMS™ Telemetry Receiver



Pg. 13

This flight-ready 12 in<sup>3</sup> receiver / demodulator / bit synchronizer features 6 to 8 dB better sensitivity than the competition and optional 5-band coverage (P, Lower L, Upper L, S, and C) for the ultimate frequency flexibility. That's exceptional performance, no matter the size.

### nanoTX™ Telemetry Transmitter



Pg. 18

Introducing the smallest multi-mode ARTM transmitter ever. At 1.3 in<sup>3</sup>, this diminutive unit offers all of the same features as its bigger brother, TIMTER™ – including PCM/FM, SOQPSK-TG, and Multi-h CPM modulation modes – while delivering 1, 2, 5, or up to 10 watts.

### TIMTER™ Telemetry Transmitter



Pg. 18

The new third generation TIMTER™ offers the finest combination of performance and value on the market. TIMTER™ is available in single or multi-band configurations with an extremely efficient power amplifier capable of delivering up to 25 watts, and plenty of optional add-ons for application-specific tailoring.

### Rack-Mount Receiver Analyzer



Pg. 36

With two complete ARTM signal generators covering 200 MHz to 2500 MHz and 4.4 GHz to 5.25 GHz contiguously and power levels from 0 dBm to -130 dBm, the Receiver Analyzer automates a wide range of receiver and combiner performance tests including bit error rate, noise figure, acquisition time and threshold, combiner break frequency, and PCM/FM modulation index tests. Eight bit error rate testers include integrated synchronization detection/timing and bit clock frequency counters.

Specifications subject to change without notice

ISO 9001:2015  
Certified

All Quasonix products are  
under U.S.  
Dept. of Commerce  
jurisdiction categorized as  
EAR99 (Tx) or 5A991 (Rx)

## 3rd GENERATION RACK-MOUNT RDMS™ TELEMETRY RECEIVER

1U  
Chassis



3U  
Chassis



- **Complete Receiver – RF to Bits**

*A single-box solution that includes downconversion, demodulation, and bit synchronization*

- **Space Time Coding (STC) with SOQPSK Mode**

*Space Time Coding (STC) operates with Quasonix STC-enabled transmitters to eliminate the dropouts caused by transmit antenna pattern nulls due to inter-antenna interference*

- **Low Density Parity Check (LDPC) Coding with SOQPSK Mode**

*Low Density Parity Check coding operates with Quasonix LDPC-enabled transmitters to improve link margin by up to 9 dB, while still using 22% less bandwidth than PCM/FM at the same payload data rate*

- **Data Quality Encapsulation (DQE) and Data Quality Metric (DQM)**

*Data Quality Encapsulation (DQE) is a process of bundling Data Quality Metric words with payload data, including a sync word to aid BSS time alignment; built-in real-time DQM display*

- **Best-Channel Selector (BCS)**

*Combiner data output seamlessly selects the best channel (Channel 1, Channel 2, or Pre-Detection Diversity Combiner) based on DQM*

- **Built-in Integrated Three-channel Spectrum Analyzer**

*Spectrum analyzer shows frequency domain view for up to three channels simultaneously*

- **Optional Adaptive Equalizer**

*Powerful decision-directed equalizer mitigates multipath distortion*

- **Pre-Detection Diversity Combiner**

*Provides Maximal Ratio Combining with gain virtually indistinguishable from theory. Also features a revolutionary dynamic time alignment function which increases the allowable time skew between channels by over 1300 nanoseconds—more than 60 bits at high bit rates!*

- **Built-in Playback Demodulator**

*IF Inputs for each channel, 75 kHz to 20 MHz, or 70 MHz with selectable SAW filter*

- **Simultaneous RS-422 and TTL Outputs with All Units**

*One RDMS does it all—no need to order separate output options*

- **Tuning Range from 200 MHz to 5250 MHz**

*Optional contiguous tuning from 200 MHz through 2500 MHz and 4400 MHz through 5250 MHz*

## 3<sup>rd</sup> GENERATION RACK MOUNT RDMS™ TELEMETRY RECEIVERS

- Versatile Rack-Mount Enclosures**  
Legacy 1U or 3U 19" rack-mount chassis houses one or two receiver channels covering P, lower L, upper L, full S, C, or multiple bands per channel
- Easy Field Upgrades**  
Available software and firmware updates may now be installed by the customer on-site
- Best SOQPSK-TG Detection in the Industry**  
RDMS' trellis detection for SOQPSK-TG yields improvements of 2 dB or more over the competition's single-symbol detectors
- True Trellis Demodulation in all ARTM Modes**  
Provides true multi-symbol trellis detection in all three ARTM modes for optimal demodulation
- 3.5 to 5 dB Improvement in PCM/FM Performance**  
Improves BER performance by 3.5 to 5 dB over single-symbol demodulators, to within 0.2 dB of the theoretical limit
- Enhanced Modulation Index Tracking\* for PCM/FM**  
Maintains superior BER performance even if the received signal's modulation index varies by as much as 500%, a major breakthrough for tracking legacy analog transmitters (\*patented)
- Automatic Phase Noise Compensation**  
Optimizes demodulator performance for use with legacy TM packs and transmitters with excessive phase noise; can engage automatically, when needed, to provide optimal performance
- Lowest Noise Figure**  
Typical 3.5 dB noise figure bests all other ARTM receivers on the market, hands down
- Rapid Synchronization**  
Synchronizes up to 100 times faster – and maintains sync at lower signal-to-noise ratios – than any other ARTM demodulator

**Combiner OFF—Two Independent Receivers—Two Control Windows**

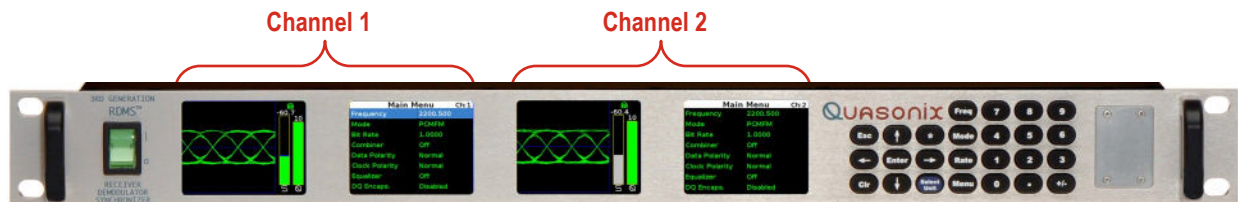

**Combiner ON—Single Control Window**



**Aux Analog Outputs**

**Combiner I & Q Outputs**



**70 MHz IF Inputs for each Channel**

**Combiner IF Output**



**3U Touchscreen Chassis!**

*You haven't seen a telemetry receiver like this*

- **Intuitive, Full Color, 7-Inch Touchscreens**  
Dual 7-inch touchscreens allow the operator to display the appropriate eye pattern or constellation for a particular waveform mode, AND the spectrum image associated with the mode
- **More Clock and Data Outputs**  
Twice as many clock and data outputs as a 1U RDMS™
- **More Analog Outputs**  
Additional high speed DAC outputs and auxiliary analog outputs on each channel

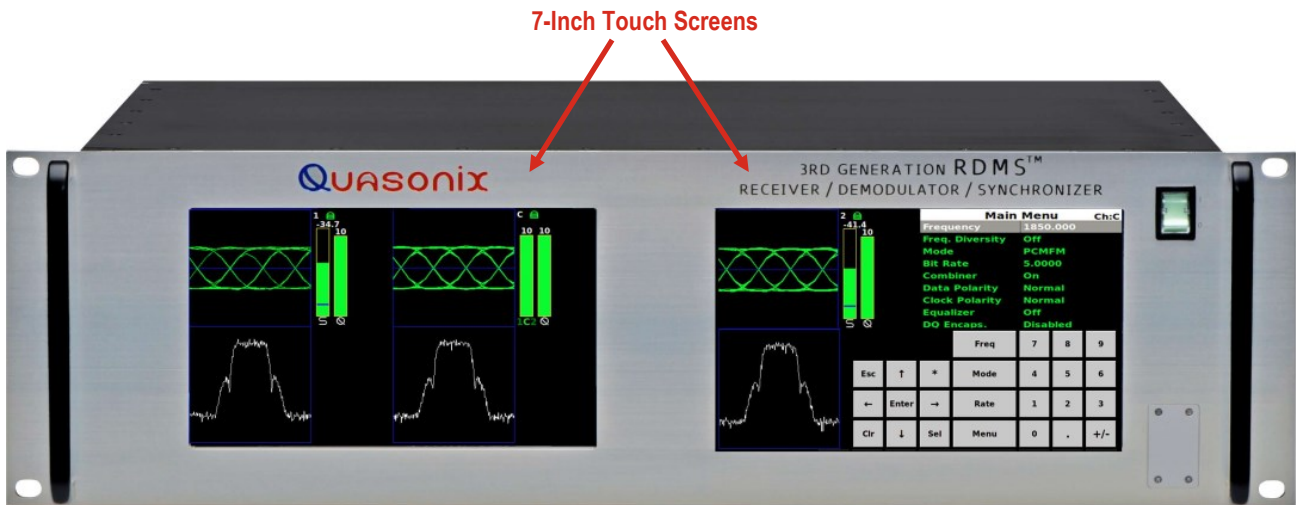

3U Back Panel



# REMOTE RDMS™ CLIENT

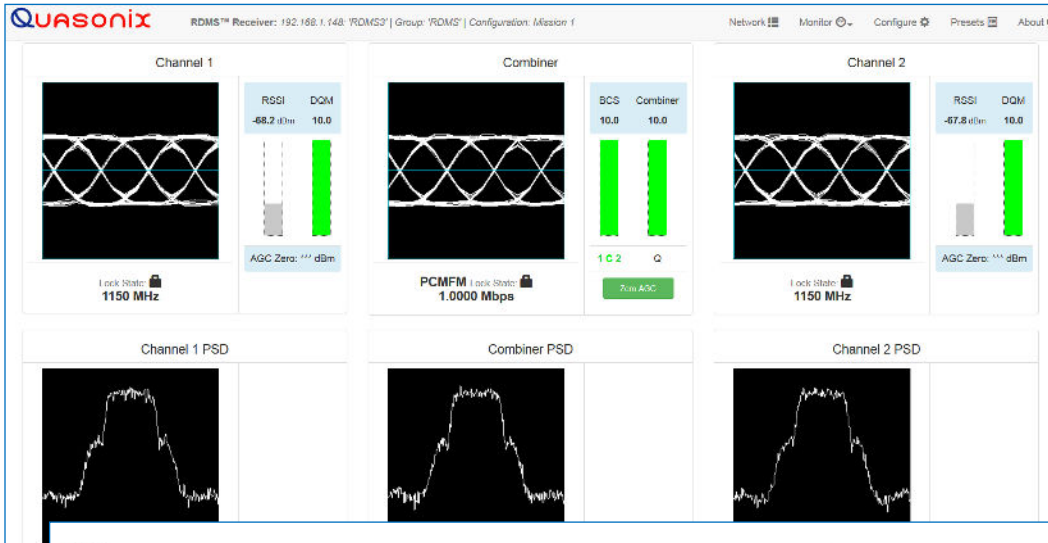

## Features

- ⇒ Browser-based interface—works with common web browsers
- ⇒ Intuitive layout with all primary control and monitoring functionality for Channel 1, Channel 2, and Combined Channel in one window

This screenshot shows the configuration page of the Remote RDMS Client. It includes a top section for general information (Name, Description, Mission Description) and buttons for 'Bond Settings', 'Save As Preset', and 'Refresh'. Below this are configuration sections for Channel 1, Channel 2, System Settings, and Ch1/Ch2. A red warning message at the top right states: "Changes affect the current active configuration."

The screenshot shows the Network page of the Remote RDMS Client. It features a table listing all channels and combiners. A message at the top indicates: "All viewed channels are not locked. (Channels shown: 11 Channels not shown: 0)".

Show	RDMS Address	Configuration Name	Channel	Frequency (MHz)	Mode	Bit Rate (Mbps)	dBm	DQM	Lock Status	Action
<input checked="" type="checkbox"/>	192.168.1.159	Mission 0	1	2200.500	PCMFPM	1.000000	-61.13	10.00	Locked	Configure Monitor
<input checked="" type="checkbox"/>			C					10.00	Locked	
<input checked="" type="checkbox"/>			2				-58.87	10.00	Locked	
<input checked="" type="checkbox"/>	192.168.1.10	Mission 0	1	2200.500	STC	5.000000	-82.76	8.25	Locked	Configure Monitor
<input checked="" type="checkbox"/>			C					9.33	Locked	
<input checked="" type="checkbox"/>			2				-81.98	7.88	Locked	
<input checked="" type="checkbox"/>	192.168.1.172	Mission 0	1	1800.000	SOQPSK	10.000000	-105.45	0.00	Not Locked	Configure Monitor
<input checked="" type="checkbox"/>			2				-83.94	0.00	Not Locked	
<input checked="" type="checkbox"/>	192.168.1.71	Mission 0	1	2211.000	SOQPSK	11.000000	-90.91	4.20	Locked	Configure Monitor
<input checked="" type="checkbox"/>			C					7.65	Locked	
<input checked="" type="checkbox"/>			2				-90.97	4.14	Locked	

### Data Quality Metric (DQM)

Data Quality Metric (DQM) is embedded in the PCM stream and based on statistics developed deep inside the demodulator. It is calculated directly from BEP. The use of a Likelihood Ratio leads to maximum likelihood BSS algorithms.

#### • DQM Accuracy Verified Under Various Channel Impairments

- AWGN-static level
- AWGN-dynamic level (step response)
- Dropouts
- In-band and adjacent channel interference
- Phase noise
- Timing jitter
- Static multipath
- Dynamic multipath (similar to break frequency test)

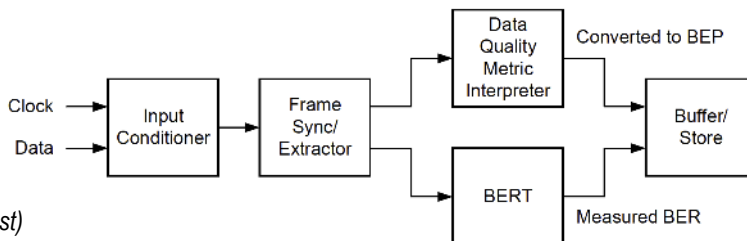

### Data Quality Encapsulation (DQE)

Data Quality Metric (DQM) is embedded in the PCM stream and based on statistics developed deep inside the demodulator. Data Quality Encapsulation (DQE) bundles payload data with its DQM to give the Best Source Selectors a valid basis for “Best!”

#### IRIG DQE Format

##### • Header

- 16-bit sync pattern (0xFAC4)
  - ◊ MSB first: 1111101011000100
- 16-bit ID word (format TBD)
- 16-bit DQM =  $\min(\text{round}(-\log_{10}(\text{LR}) / 12 * (2^{16})), 2^{16} - 1)$ 
  - ◊ 16-bit unsigned integer, ranges from 0 to 65,535
  - ◊ Likelihood Ratio (LR) =  $\text{BEP} / (1 - \text{BEP})$
  - ◊ Easily reversed:
    - $\text{LR} = 10^{(-12 * \text{DQM} / 2^{16})}$
    - $\text{BEP} = \text{LR} / (1 + \text{LR})$
  - ◊ Q is defined as the “User’s DQM”:
    - $\text{Q} = 12 * \text{DQM} / 65536$
    - Represents the exponent of 10 in the LR, which approximates the BEP

##### • Payload Data

- User selectable length, defaults to 4096, except for STC mode, where the default is 3200 bits, and SOQPSK/LDPC or STC/LDPC mode, where the default is the selected LDPC block size

##### • Network BW Expansion of ~1%

BEP	LR	DQM	Q
0.5	1.00	0	0.00
1E-01	1.11111E-01	5211	0.95
1E-02	1.01010E-02	10899	2.00
1E-03	1.00100E-03	16382	3.00
1E-04	1.00010E-04	21845	4.00
1E-05	1.00001E-05	27307	5.00
1E-06	1.00000E-06	32768	6.00
1E-07	1.00000E-07	38229	7.00
1E-08	1.00000E-08	43691	8.00
1E-09	1.00000E-09	49152	9.00
1E-10	1.00000E-10	54613	10.00
1E-11	1.00000E-11	60075	11.00
1E-12	1.00000E-12	65535	12.00

### Telemetry over IP (TMolP)

The Quasonix TMolP Processor (QTP) core provides IRIG 218-20 compliant telemetry transport in a 3-channel integrated solution embedded in a 1U or 3U RDMS receiver (RDMS with the IP2 option). It provides accurate, reliable transport of all received telemetry data streams from the RDMS to the range network, while offering a multitude of features.

### The Power of Diversity

Quasonix makes great receivers, but even the best receiver may be limited by range, obstacles/shading, multipath, interference, etc. That’s where diversity comes in. Using multiple copies of the transmitted signal—arriving via separate pathways—can dramatically reduce the likelihood of “data dropouts”. The RDMS™ supports diversity at two levels: within each rackmount receiver through our innovative Best Channel Selector (BCS), and between multiple rackmount receivers connected to a Best Source Selector (BSS), through Data Quality Encapsulation (DQE).

Simplified Block Diagram

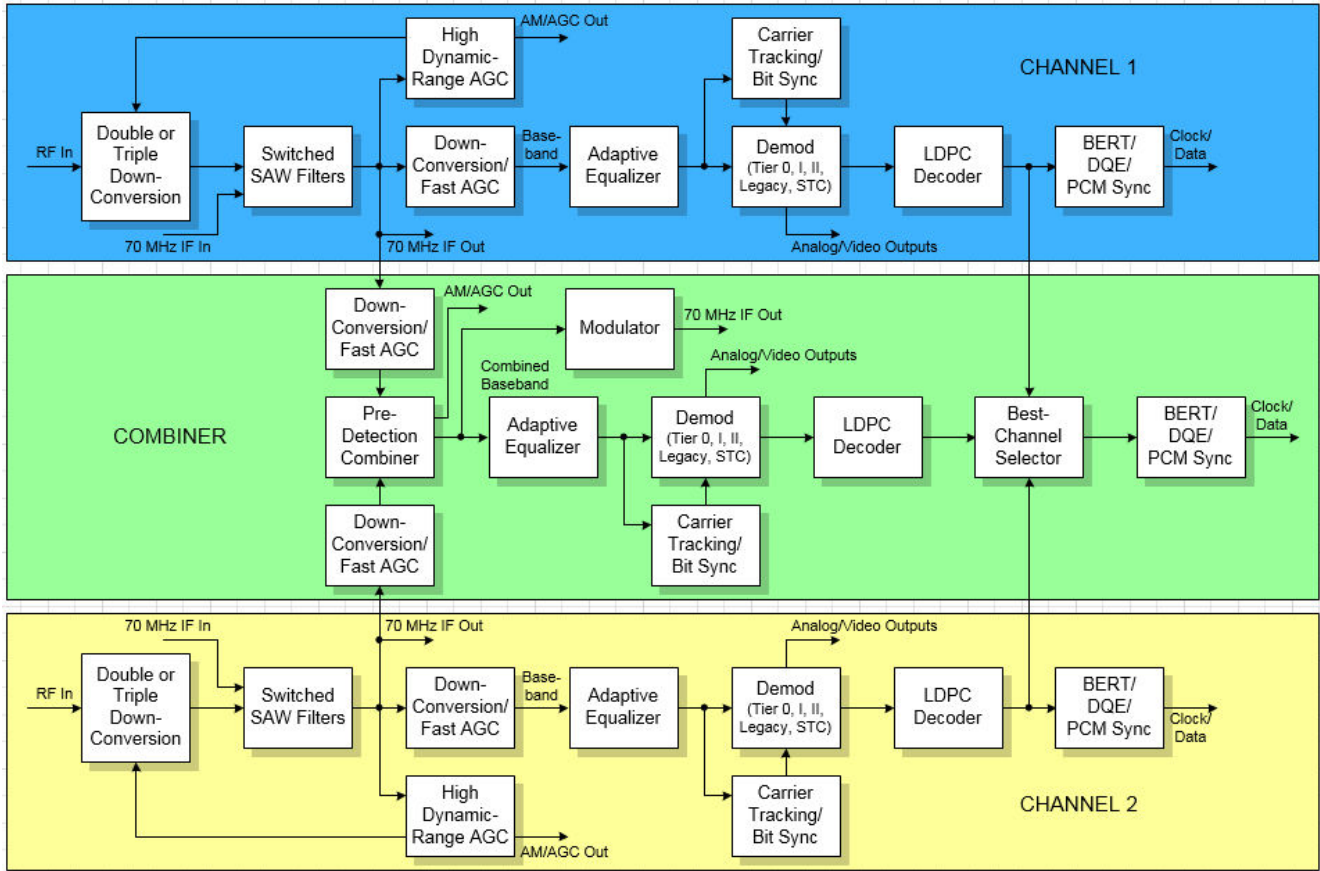

Bit Error Rate Testing (BERT)

- **User-selectable Pattern**
  - PN6, PN9, PN11, PN15, PN17, PN20, PN23, PN31
  - Any fixed-length pattern from 2 to 32 bits
- **Standard Operating Modes**
  - Continuous
  - Single
  - Repeating
- **Accurate measurement even above 40% bit error rate**
- **Test Termination Section**
  - Bit count limit
  - Error count limit
  - Time limit
- **Loggable Text Results**
  - Human-friendly
  - Excel-friendly
- **Automatic data inversion detection**

Example display with a five (5) second repeating test. An asterisk \* after the Error Rate indicates the data is inverted.

E	R	Time	Bit Count	Error Count	Error Rate
#	!	0:00:00:03.772	3.773e+07	2	5.301e-08*
#	!	0:00:00:04.023	4.023e+07	2	4.971e-08*
#	!	0:00:00:04.276	4.276e+07	2	4.677e-08*
#	!	0:00:00:04.527	4.528e+07	2	4.417e-08*
#	!	0:00:00:04.779	4.780e+07	2	4.184e-08*
>>>		0:00:00:05.000	5.000e+07	2	4.000e-08*
#	!	0:00:00:00.251	2.512e+06	0	0.000e+00*
#	!	0:00:00:00.503	5.032e+06	0	0.000e+00*
#	!	0:00:00:00.757	7.574e+06	2	2.641e-07*
#	!	0:00:00:01.011	1.011e+07	2	1.978e-07*
#	!	0:00:00:01.263	1.264e+07	2	1.582e-07*



## DEMODULATOR SYNCHRONIZATION PERFORMANCE

### Synchronization Overview

Quasonix is the only vendor in the telemetry market offering trellis demodulation in all ARTM modes. Not only does this approach yield BER results that are less than 0.2 dB from the theoretical limits, but it brings unprecedented synchronization performance.

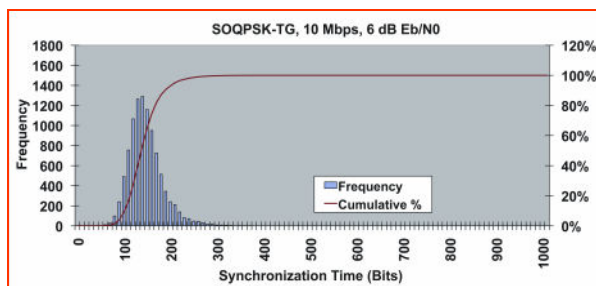
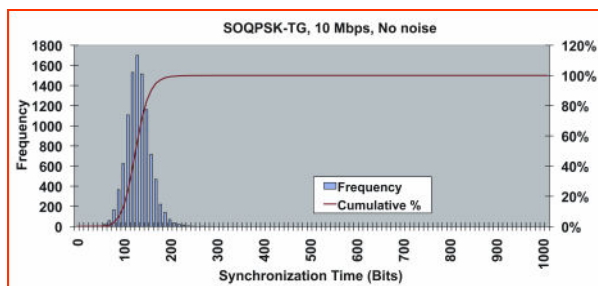

### Synchronization Time

The entire Quasonix receiver and demodulator product line offers extremely fast synchronization in all modes. Our trellis-based synchronization engine provides sync times as short as 100 bits on average.

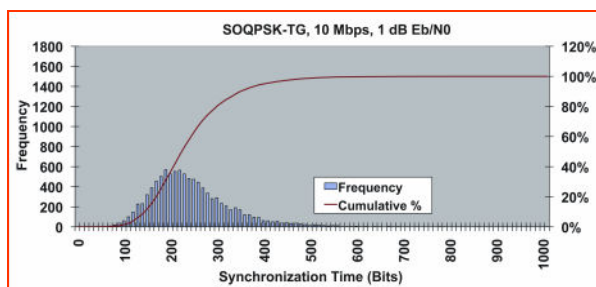
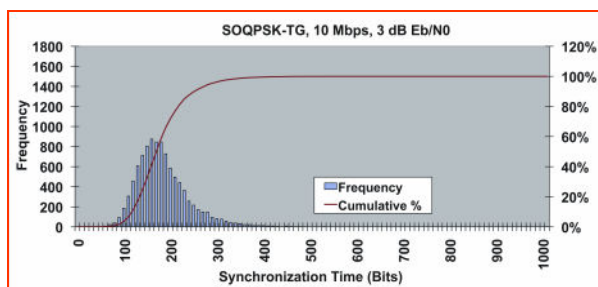

### Synchronization Threshold

Only Quasonix can show synchronization times at negative Eb/N0 values because we're the only vendor with trellis demodulators that can operate in this region. Our ability to achieve synchronization at such low signal to noise ratios means that we can maintain bit count integrity through extremely deep fades. This allows the user's crypto devices to stay synchronized under the most severe fading conditions, thereby eliminating the long data outages that occur when the crypto devices lose sync.

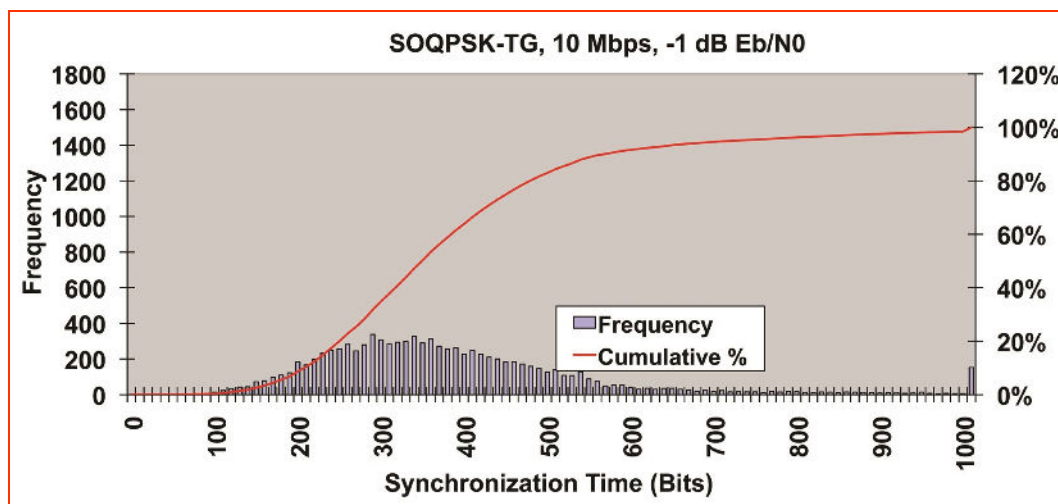



# RACK MOUNT RECEIVER ORDERING INFORMATION

## PART NUMBERS

### Rack Mount RDMS™ Part Numbering Example

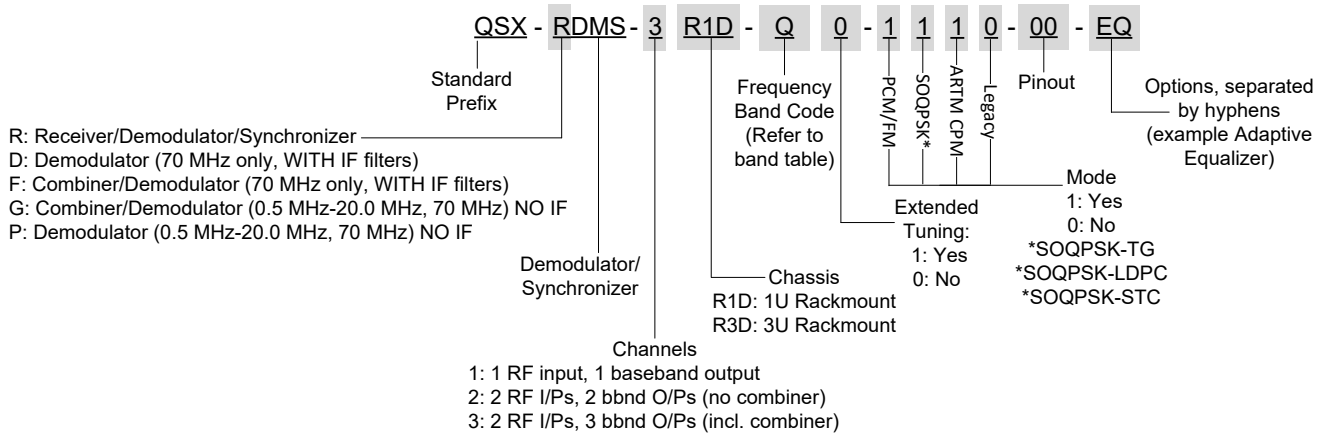

### You CAN have it all!

Imagine five frequency bands all in a compact 1U package OR in a 3U package with touchscreen—and with Quasonix' Extended Tuning Range option, our receivers will tune from 200 MHz to 2500 MHz and 4.4 GHz to 5.25 GHz, meeting or exceeding the range of the competition.



**New Third Generation 1U Chassis—  
Same reliable Quasonix performance!**

**Third Gen 3U Touchscreen Chassis—  
Same RDMS™ functionality as the 1U with  
the convenience of touchscreens and  
unparalleled output capability!**



Available Options	
Option	Option Description
14	14 SAW filters (adds 70 kHz, 1.4, 3, 6, 14, and 28 MHz filters)
CS	Cybersecurity
EQ	Adaptive Equalizer
K7	K7 Viterbi Decoder (k=7 rate 1/2)
IP2	Telemetry Over IP
IP	Legacy Telemetry Over IP (limited time)

### MDM-25 Cables

The RS-422 connectors must be connected to a 12 twisted pair shielded cable, such as a Glenair 177-740-2-25CS4K1-36MCN. This particular cable is 36 inches or 3 feet long. Other lengths are available.

Note: Only 8 twisted pairs are used per 3U RDMS™ connector. The 1U RDMS™ uses all 12 twisted pairs.

# RACK MOUNT RECEIVER BAND CONFIGURATIONS

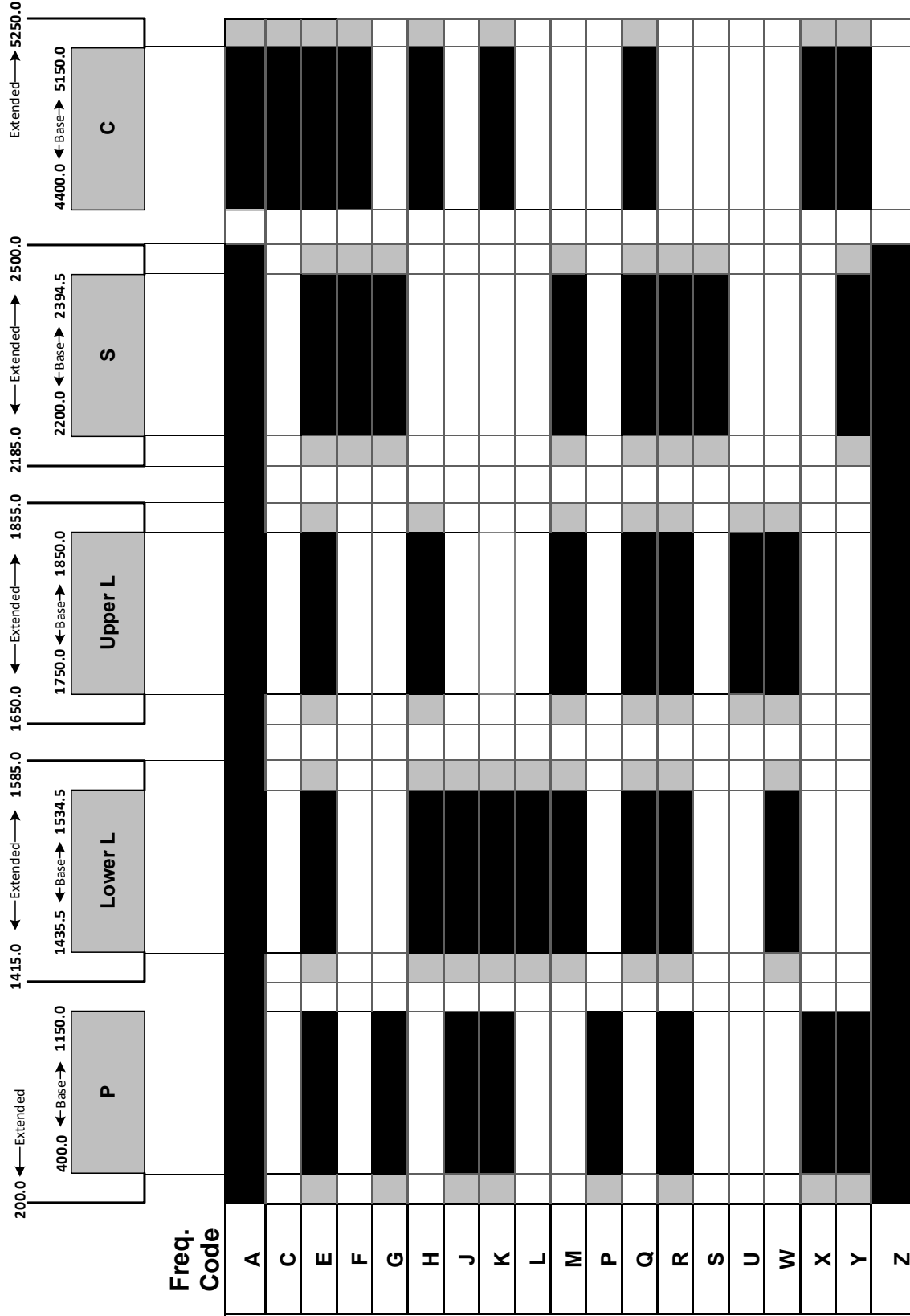

Legend:

- Frequency Gap
- Standard (Base) Frequency Range
- Extended Frequency Range

(available by selecting Extended Tuning = 1 in part number)

\* Also Available:

- Band Code 7: 70 MHz standard range, 0.5 MHz—20 MHz, 70 MHz extended range
- Band Code T: 2025.0 MHz to 2110.0 MHz standard range

## RACK MOUNT RECEIVER SPECIFICATIONS

Characteristic	Specification
<b>Receiver Section</b>	
Type	Dual-conversion superheterodyne
Input RF Frequency	Refer to page 10
Tuning resolution	Tunes in 62.5 kHz increments, to the 70 MHz IF output; after the 70 MHz IF output, receiver tunes in increments of less than 1 Hz
Frequency stability	1 ppm over temperature; 1 ppm per year aging
Reference oscillator	20 MHz
Noise figure	3.5 dB (typical), 5 dB (maximum)
LO phase noise, measured at 70 MHz IF output	-115 dBc/Hz @ 1 MHz offset
Maximum RF input	+20 dBm (+10 dBm for C-band)
Available gain (to 70 MHz IF output)	114 dB
Gain control	128 dB control range; User selectable: AGC or MGC (AGC freeze)
AGC load impedance	1 KOhm
AGC time constant	Adjustable to any value from 0.1 ms to 1000 ms
First IF bandwidth	60 MHz (nominal)
IF rejection	> 90 dB
Image rejection	70 dB
RF input impedance	50 ohms
VSWR	3:1 Max; 2:1 Typical
<b>Second IF Section</b>	
IF frequency	70 MHz
IF output level, nominal (AGC mode)	Channel 1 and 2: 70 and 250 kHz bandwidths: -15 dBm 0.5 – 4.5 MHz bandwidths: -10 dBm 6 and 10 MHz bandwidths: -5 dBm 14 - 40 MHz bandwidths: -15 dBm Combiner: -5 dBm Channel 1 and 2 Mod Out: -5 dBm (3U RDMS only)
IF output impedance	50 ohms
VSWR	2:1 Max; 1.5:1 Typical
IF bandwidths	250 kHz, 500 kHz, 1 MHz, 2 MHz, 4.5 MHz, 10 MHz, 20 MHz, 40 MHz. Automatic selection based on modulation type and data rate, with manual override. Optional: 70 kHz, 1.4 MHz, 3 MHz, 6 MHz, 14 MHz, 28 MHz
<b>Playback Demodulator IF In, Channel 1 and 2 Section</b>	
Input Center Frequency	.075-20 MHz, 70 MHz through any SAW filter
Input Level	-30 dBm ±10 dB
Input Impedance	50 ohms, nominal

Specifications subject to change without notice

## RACK MOUNT RECEIVER SPECIFICATIONS

Characteristic	Specification
<b>Demodulator Section</b>	
Demodulator type	ARTM Tier 0 (PCM/FM), Tier I (SOQPSK-TG), Tier II (Multi-h CPM) Legacy suite: Analog FM, BPSK, QPSK, Offset QPSK (OQPSK), Asymmetric QPSK (AQPSK), Unbalanced QPSK (UQPSK), Asymmetric Unbalanced QPSK (AUQPSK), Digital PM, Space Time Coding (STC)
Bit Rates (after LDPC encoding, if applicable)	Tier 0: 24 kbps to 23 Mbps in 1 bps steps Tier I: 100 kbps to 46 Mbps in 1 bps steps Tier II: 1 Mbps to 46 Mbps in 1 bps steps STC: 5 Mbps to 22 Mbps in 1 bps steps Legacy: 25 kbps to 23 Mbps in Analog FM, 25 kbps to 23 Mbps in BPSK, 50 kbps to 46 Mbps in QPSK in 1 bps steps
Synchronization time (Average, at BER = 1e-5)	Tier 0: 250 bits, Tier I: 385 bits, Tier II: 2,800 bits
Synchronization acquisition threshold	Tier 0: -5.0 dB Eb/N0; RF Input (dBm): -115.0 (1 Mbps), -105.0 (10 Mbps) Tier I: -4.0 dB Eb/N0; RF Input (dBm): -114.0 (1 Mbps), -104.0 (10 Mbps) Tier II: -8.0 dB Eb/N0; RF Input (dBm): -118.0 (1 Mbps), -108.0 (10 Mbps)
Synchronization dropout threshold	Tier 0: -10.0 dB Eb/N0; RF Input (dBm): -120.0 (1 Mbps), -110.0 (10 Mbps) Tier I: -6.0 dB Eb/N0; RF Input (dBm): -116.0 (1 Mbps), -106.0 (10 Mbps) Tier II: -15.0 dB Eb/N0; RF Input (dBm): -125.0 (1 Mbps), -115.0 (10 Mbps)
Sensitivity (BER = 1e-5)	Tier 0: 8.6 dB Eb/N0; RF Input (dBm): -101.4 (1 Mbps), -91.4 (10 Mbps) Tier I: 11.2 dB Eb/N0; RF Input (dBm): -98.8 (1 Mbps), -88.8 (10 Mbps) Tier II: 13.0 dB Eb/N0; RF Input (dBm): -97.0 (1 Mbps), -87.0 (10 Mbps)
<b>Bit Synchronizer Section</b>	
Input codes	NRZ-L/M/S, BIΦ-L/M/S, RZ, DM-M/S, M2-M/S
Output codes	NRZ-L; or input code unaltered
Data and clock out	TTL (BNC) or RS-422
Lock detector out	TTL
Derandomizer	Standard IRIG 15-stage polynomial, selectable On/Off
<b>Video Section</b>	
Video out (DC to 35 MHz)	1U—Quad wideband outputs: Ch1 and Ch2; Dual wideband outputs, Combiner 3U—Quad wideband outputs: Ch1, Ch2, and Combiner
Video filter bandwidth	User programmable
Output level	1 Vp-p nominal, 4 Vp-p maximum
Video de-emphasis	Selectable Off/NTSC/PAL
<b>Environmental Section</b>	
Operating Temperature	0°C to +50°C
Storage Temperature	-20°C to +70°C
Operating Humidity	0 to 95% (non-condensing)
Altitude	Up to 30,000 ft. (with the no displays options)
<b>Physical Section</b>	
Size	1U rack-mount chassis: 18.95" wide, 1.72" tall, 14.00" rack depth, 14.74" overall depth 3U rack-mount chassis: 18.95" wide, 5.22" tall, 14.06" rack depth, 14.80" overall depth
Weight	1U: 11.4 lbs. (dual-channel) 3U: 16.0 lbs.
Power	100 to 240 VAC, 50/60 Hz

Specifications subject to change without notice



## 3<sup>rd</sup> GENERATION COMPACT RDMS™ TELEMETRY RECEIVER



12 in<sup>3</sup>

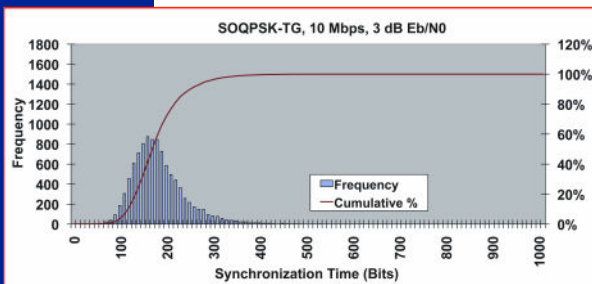
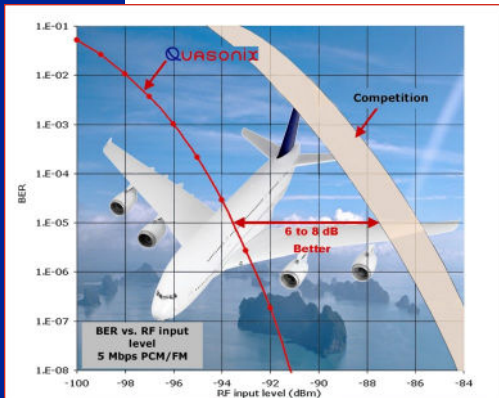

- **Complete Receiver – RF to Bits**

A single-box solution that accepts RF signals, and delivers baseband clock and data. No external add-ons required.

- **Available with Adaptive Equalization**

Reduces dropouts caused by multipath reflections

- **Compact Flight-Ready Package**

Ultra-compact 12 cubic-inch chassis affords flexibility with system integration

- **True Trellis Demodulation in all ARTM Modes**

Provides true trellis detection in all three ARTM modes for optimal demodulation

- **3.5 to 5 dB Improvement in PCM/FM Performance**

Improves BER performance by 3.5 to 5 dB over the best single-symbol demodulators to within 0.2 dB of the theoretical limit

- **Modulation Index Tracking\* for PCM/FM**

Maintains superior BER performance even if the received signal's modulation index varies by as much as 500%, a breakthrough for tracking legacy analog transmitters (\*patented)

- **Phase Noise Compensation**

Optimizes demodulator performance for use with legacy TM packs and transmitters with excessive phase noise

- **Best SOQPSK-TG Detection in the Industry**

RDMS's trellis detection for SOQPSK-TG yields improvements of 2 dB or more over the competition's single-symbol detectors

- **Lowest Noise Figure**

3.5 dB noise figure bests all other ARTM receivers on the market, hands down

- **Rapid Synchronization**

Synchronizes up to 100 times faster – and maintains sync at lower signal-to-noise ratios – than any other ARTM demodulator

## **PERFORMANCE. PERIOD.**

Quasonix' multi-mode compact telemetry receiver combines an extremely sensitive RF front end with superior ARTM waveform detection, demodulation, and bit synchronization in a compact 12 cubic-inch flight- ready package.

By combining a noise figure of 3.5 dB and multi-symbol trellis demodulation that produces 2 to 5 dB better detection efficiency than competing demodulators in all three ARTM modes, the Quasonix Receiver achieves a remarkable **6 to 8 dB advantage in receive sensitivity** over the industry's previous standard-bearers.

The 12 cubic inch (3.00" x 4.00" x 1.00") Compact RDMS™ Receiver is available for P band (200.0 – 1150.0 MHz), Lower L band (1415.0 - 1585.0 MHz), Upper L band (1650.0 - 1855.0 MHz), S band (2185.0 - 2500.0 MHz), and C band (4400.0 – 5250.0 MHz). A brand new, and market-first, **5-band** version—covering all of these bands—is now available.

Options for the RDMS™ include a finned heat sink cover for better heat dissipation, a double-rate SOQPSK mode for operation up to 46 Mbps, and a 37-pin MDM connector for additional output signals, including multiple sets of clock and data, and both high-speed and low-speed analog outputs.



Photo courtesy of U. S. Air Force



## COMPACT RDMS™ TELEMETRY RECEIVER SPECIFICATIONS

Characteristic	Specification
<b>Receiver Section</b>	
Type	Dual-conversion superheterodyne
Input RF Frequency	Refer to page 17
Tuning resolution	Tunes in 62.5 kHz increments, to the 70 MHz IF output; after the 70 MHz IF output, receiver tunes in increments of less than 1 Hz
Frequency stability	1 ppm over temperature 1 ppm per year aging
Reference oscillator	20 MHz
Noise figure	3.5 dB (typical), 5 dB (maximum)
LO phase noise, measured at 70 MHz IF output	-115 dBc/Hz @ 1 MHz offset
Maximum RF input	+20 dBm (+10 dBm for C-band)
Available gain (to 70 MHz IF output)	114 dB
Gain control	128 dB control range; User selectable: AGC or MGC (AGC freeze)
AGC time constant	Adjustable, 0.1 ms to 1000 ms
First IF bandwidth	60 MHz (nominal)
IF rejection	> 90 dB
Image rejection	70 dB
RF input impedance	50 ohms
<b>Second IF Section</b>	
IF frequency	70 MHz
IF output level	-10 to -20 dBm nominal (AGC mode)
IF output impedance	50 ohms
IF bandwidths	250 kHz, 500 kHz, 1 MHz, 2 MHz, 4.5 MHz, 10 MHz, 20 MHz, 40 MHz. Automatic selection based on data rate, with manual override Optional: 70 kHz, 1.4 MHz, 3 MHz, 6 MHz, 14 MHz, 28 MHz
<b>Demodulator Section</b>	
Demodulator type	ARTM Tier 0 (PCM/FM), ARTM Tier I (SOQPSK-TG), ARTM Tier II (Multi-h CPM) Legacy suite: Analog FM, BPSK, QPSK, Offset QPSK (OQPSK), Asymmetric QPSK (AQPSK), Unbalanced QPSK (UQPSK), Asymmetric Unbalanced QPSK (AUQPSK), Digital PM, Space Time Coding (STC)
Bit Rates	Tier 0: 24 kbps to 23 Mbps in 1 bps steps Tier I: 100 kbps to 46 Mbps in 1 bps steps Tier II: 1 Mbps to 46 Mbps in 1 bps steps STC: 5 Mbps to 22 Mbps in 1 bps steps Legacy: 25 kbps to 23 Mbps in Analog FM, 25 kbps to 23 Mbps in BPSK, 50 kbps to 46 Mbps in QPSK in 1 bps steps
Synchronization time (Average, at BER = 1e-5)	Tier 0: 250 bits, Tier I: 385 bits, Tier II: 2,800 bits
Synchronization threshold	Tier 0: -8.0 dB Eb/N0; RF Input (dBm): -118.0 (1 Mbps), -108.0 (10 Mbps) Tier I: -6.0 dB Eb/N0; RF Input (dBm): -116.0 (1 Mbps), -106.0 (10 Mbps) Tier II: -7.0 dB Eb/N0; RF Input (dBm): -117.0 (1 Mbps), -107.0 (10 Mbps)
Sensitivity (BER = 1e-5)	Tier 0: 8.6 dB Eb/N0; RF Input (dBm): -101.4 (1 Mbps), -91.4 (10 Mbps) Tier I: 11.2 dB Eb/N0; RF Input (dBm): -98.8 (1 Mbps), -88.8 (10 Mbps) Tier II: 13.0 dB Eb/N0; RF Input (dBm): -97.0 (1 Mbps), -87.0 (10 Mbps)

Specifications subject to change without notice



## COMPACT RDMS™ TELEMETRY RECEIVER SPECIFICATIONS

Characteristic	Specification
<b>Bit Synchronizer Section</b>	
Input codes	NRZ-L/M/S, BIΦ-L/M/S
Output codes	NRZ-L; or input code unaltered
Data and clock out	TTL or RS-422
Lock detector out	TTL
RSSI	Single 0 – 5 VDC, 2 MHz bandwidth (-37 option required)
Video out	Four (4) wideband outputs, DC to 35 MHz (-37 option required)
<b>Environmental Section</b>	
Operating Temperature	-20°C to +70°C
Non-operating Temperature	-40°C to +85°C
Operating Humidity	0 to 95% (non-condensing)
Vibration	20 G, 5 Hz to 2 kHz (all axes)
Acceleration	100 G (all axes)
Shock	100 G pk, half-sine, 5 ms (all axes)
Altitude	Up to 100,000 ft.
<b>Physical Section</b>	
Size / Weight	4.00" x 3.00" x 1.00" / 11 oz.
Connectors	RF input: SMA female IF output: SMA female Baseband: MDM-15 or MDM-37 ("37" option)
Power	28 VDC ± 4 VDC, 750 mA typical
Inrush Current	12 VDC, 3.3 A max (as measured with a Fluke i30s AC/DC current clamp)

## OPTIONAL FEATURES

- > 14 14 SAW filters (adds 70 kHz, 1.4, 3, 6, 14, and 28 MHz filters)
  - > EN Ethernet Payload
  - > ET Extended temperature range (-40°C to +85°C)
- > EQ Adaptive Equalizer
  - > K7 K7 Viterbi Decoder (k=7, rate 1/2)
  - > WV Wide operating voltage (15 – 35 VDC)

### Compact RDMS™ Part Numbering Example

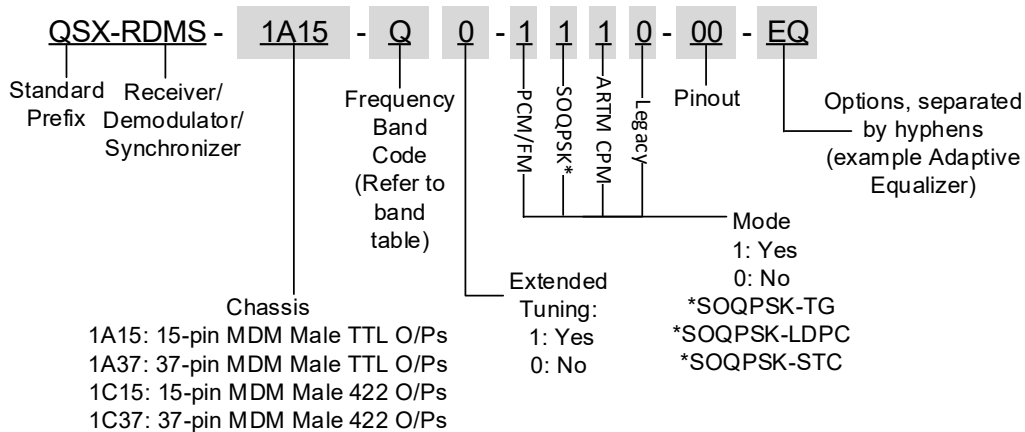





# COMPACT RDMS™ TELEMETRY RECEIVER SPECIFICATIONS

Freq. Code	200.0 ← Extended → 400.0 ← Base → 1150.0		1415.0 ← Extended → 1435.5 ← Base → 1534.5		1585.0 ← Extended → 1650.0 ← Base → 1750.0 ← Extended → 1850.0		2185.0 ← Extended → 2200.0 ← Base → 2394.5		4400.0 ← Base → 5150.0 Extended → 5250.0	
	P		Lower L		Upper L		S		C	
A	Black	Black	Black	Black	Black	Black	Black	Black	Black	Black
C	Black	Black	Black	Black	Black	Black	Black	Black	Black	Black
E	Black	Black	Black	Black	Black	Black	Black	Black	Black	Black
F	Black	Black	Black	Black	Black	Black	Black	Black	Black	Black
G	Black	Black	Black	Black	Black	Black	Black	Black	Black	Black
H	Black	Black	Black	Black	Black	Black	Black	Black	Black	Black
J	Black	Black	Black	Black	Black	Black	Black	Black	Black	Black
K	Black	Black	Black	Black	Black	Black	Black	Black	Black	Black
L	Black	Black	Black	Black	Black	Black	Black	Black	Black	Black
M	Black	Black	Black	Black	Black	Black	Black	Black	Black	Black
P	Black	Black	Black	Black	Black	Black	Black	Black	Black	Black
Q	Black	Black	Black	Black	Black	Black	Black	Black	Black	Black
R	Black	Black	Black	Black	Black	Black	Black	Black	Black	Black
S	Black	Black	Black	Black	Black	Black	Black	Black	Black	Black
U	Black	Black	Black	Black	Black	Black	Black	Black	Black	Black
W	Black	Black	Black	Black	Black	Black	Black	Black	Black	Black
X	Black	Black	Black	Black	Black	Black	Black	Black	Black	Black
Y	Black	Black	Black	Black	Black	Black	Black	Black	Black	Black
Z	Black	Black	Black	Black	Black	Black	Black	Black	Black	Black

Legend:  
 Frequency Gap  
 Standard (Base) Frequency Range  
 Extended Frequency Range  
 (available by selecting Extended Tuning = 1 in part number)

\* Also Available:  
 Band Code 7: 70 MHz standard range, 0.5 MHz—20 MHz, 70 MHz extended range  
 Band Code T: 2025.0 MHz to 2110.0 MHz standard range

# QUASONIX

## MULTI-MODE TELEMETRY TRANSMITTERS

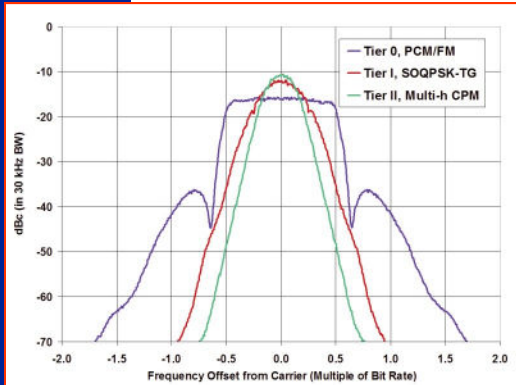

TIMTER™



TIMTER™



nanoTX™

- **Industry Leader in Transmitter Technology**  
*Providing proven quality and performance in over 15,000 transmitters shipped, TIMTER™ transmitters combine compact designs with outstanding size to power ratios, plus seamless integration and flexibility.*
- **4th Generation TIMTER™**  
*Faster processor, improved frequency stability, supports all six LDPC codes*
- **Exceptional DC-to-RF Conversion Efficiency**  
*Facilitates replacement of older 10 W transmitter with new 20 W transmitter at same current draw*
- **L, S, or C Band TIMTER™**  
*When only single band operation is needed*
- **L/C Band TIMTER™**  
*Single transmitter configuration covering a frequency tuning range spanning L and C bands*
- **S/C Band TIMTER™**  
*With output power up to 18 W, this configuration has a carrier frequency tuning range spanning S and C bands*
- **L/S Band TIMTER™**  
*Highly flexible solution available with all three legacy TM bands: lower L, upper L, and full S*
- **L/S/C Band TIMTER™**  
*Ultimate solution with lower L, upper L, full S, and full C bands*
- **Output Power from 10 mW to 25 W**  
*Several RF output choices, along with variable power and dual power options for software or hardware based power adjustment*
- **Smallest ARTM Transmitter**  
*1.3 in<sup>3</sup> nanoTX™ transmitter ideal for airborne applications with strict SWAP constraints; Available in S band*
- **Automatic Data Rate Tracking**  
*Premod filtering and deviation automatically track the data rate, with no programming or configuration required*
- **Clock-Free Input Option Available**  
*Ideal for replacing analog transmitters or for use with encoders or cryptos that provide a data output only*

Specifications subject to change without notice



## TIMTER™ TRANSMITTER SPECIFICATIONS

Characteristic	Specification
----------------	---------------

**Main Section**

Modulation type

PCM/FM (ARTM Tier 0), SOQPSK-TG (ARTM Tier I), Multi-h CPM (ARTM Tier II), BPSK, QPSK, OQPSK, UQPSK, STC

Carrier frequency tuning range

All frequency bands may be tuned 0.5 MHz above or below the stated frequency.

Note: The MA option enables operation below Lower S band frequencies (in the tuning range of 2025.0 MHz to 2110.0 MHz) for use in Space operations and Space research.

For additional information about this option or about specific frequency bands, contact Quasonix.

\*Custom frequency ranges are available. Contact Quasonix for details.

Band ID Code	Lower L band 1435.5-1534.5 MHz	Upper L band 1750.0-1855.0 MHz	Lower S band 2200.5-2300.5 MHz	Upper S band 2300.5-2394.5 MHz	C band 4400.0-4950.0 MHz	Mid C band 5091.0-5150.0 MHz	Euro Mid C band 5150.0 - 5250.0 MHz	Max Power
A			x					25 W
B						x	x	18 W
C					x			18 W
D					x	x		18 W
E	x	x	x	x	x	x	x	10 W
F			x	x	x			18 W
G							x	18 W
H	x				x			18 W
J					x	x	x	18 W
K			x	x	x	x	x	10 W
L	x							20 W
M	x	x	x	x				20 W
N				x				25 W
Q	x	x	x	x	x	x		10 W
S			x	x				20 W
T	x				x	x		18 W
V			x	x	x	x		18 W
W			x	x		x	x	18 W
X						x		18 W
Y	x	x			x	x		18 W
Z	x					x	x	18 W

RF output power

TIMTER L, S, C, L/S, L/C, and S/C bands: 10 mW, 1 W, 2 W, 5 W, 10 W, 18 W, 20 W

TIMTER S band: 10 mW, 1 W, 2 W, 5 W, 10 W, 20 W, 25 W

TIMTER L/S/C band: 10 mW, 10 W

*Option DP:* Dual power, 64 settings, user selects one for “high” and one for “low”, chosen via baseband connector pin

*Option VP:* Variable power, 64 settings approximately 0.5 dB apart;

Packages of 2 cubic inches or less: 32 settings approximately 1.0 dB apart

Specifications subject to change without notice



## TIMTER™ TRANSMITTER SPECIFICATIONS

Characteristic	Specification																																																									
Data (bit) rate, automatic rate adaptation	TIMTER: 0.1-28 Mbps (0.05-14 Mbps for PCM/FM) TIMTER <i>option</i> HR: Extends upper limit to max of 46 Mbps (23 Mbps for PCM/FM) TIMTER <i>option</i> LR: Extends lower limit to min of 50 kbps (25 kbps for PCM/FM)																																																									
Clock Free Data (bit) rate	With BR x command: Allows user to enter a fixed bit rate in the range defined in the Data (bit) rate specifications above With BR A command: Automatically detects bit rate in the range defined in the Data (bit) rate specifications above; Quasonix guarantees automatic bit rate operation up to 35 Mbps; beyond that operation is dependent on input data signal quality (jitter, truly random data, etc.)																																																									
Input current @ +28 VDC	<table border="1" style="width: 100%; border-collapse: collapse; text-align: center;"> <tbody> <tr><td>TIMTER L or S band, 10 mWatt</td><td>0.30 A max.</td><td>0.25 A typical</td></tr> <tr><td>TIMTER L or S band, 5 Watt</td><td>1.0 A max.</td><td>0.85 A typical</td></tr> <tr><td>TIMTER L or S band, 10 Watt (2in<sup>3</sup> packages)</td><td>1.4 A max.</td><td>1.1 A typical</td></tr> <tr><td>TIMTER L or S band, 10 Watt (&gt;2in<sup>3</sup> packages)</td><td>1.8 A max.</td><td>1.5 A typical</td></tr> <tr><td>TIMTER L band, 18 or 20 Watt</td><td>3.2 A max.</td><td>2.8 A typical</td></tr> <tr><td>TIMTER S band, 18 or 20 Watt</td><td>2.8 A max.</td><td>2.5 A typical</td></tr> <tr><td>TIMTER L/S band, 5 Watt</td><td>1.2 A max.</td><td>1.0 A typical</td></tr> <tr><td>TIMTER L/S band, 10 Watt</td><td>2.2 A max.</td><td>1.8 A typical</td></tr> <tr><td>TIMTER L/S band, 18 or 20 Watt</td><td>3.2 A max.</td><td>2.8 A typical</td></tr> <tr><td>TIMTER S band, 25 Watt</td><td>3.2 A max.</td><td>2.9 A typical</td></tr> <tr><td>TIMTER C band, 10 mWatt</td><td>0.30 A max.</td><td>0.25 A typical</td></tr> <tr><td>TIMTER C band, 5 Watt</td><td>1.5 A max.</td><td>1.3 A typical</td></tr> <tr><td>TIMTER C band, 10 Watt</td><td>2.4 A max.</td><td>1.9 A typical</td></tr> <tr><td>TIMTER C band, 18 Watt</td><td>3.4 A max.</td><td>3.0 A typical</td></tr> <tr><td>TIMTER L/C band and S/C band, 10 mWatt</td><td>0.30 A max.</td><td>0.25 A typical</td></tr> <tr><td>TIMTER L/C band and S/C band, 10 Watt</td><td>2.2 A max.</td><td>2.0 A typical</td></tr> <tr><td>TIMTER L/C band and S/C band, 18 Watt</td><td>3.5 A max.</td><td>3.2 A typical</td></tr> <tr><td>TIMTER L/S/C band, 10 mWatt</td><td>0.45 A max.</td><td>0.40 A typical</td></tr> <tr><td>TIMTER L/S/C band, 10 Watt</td><td>2.5 A max.</td><td>1.8 A typical</td></tr> </tbody> </table>	TIMTER L or S band, 10 mWatt	0.30 A max.	0.25 A typical	TIMTER L or S band, 5 Watt	1.0 A max.	0.85 A typical	TIMTER L or S band, 10 Watt (2in <sup>3</sup> packages)	1.4 A max.	1.1 A typical	TIMTER L or S band, 10 Watt (>2in <sup>3</sup> packages)	1.8 A max.	1.5 A typical	TIMTER L band, 18 or 20 Watt	3.2 A max.	2.8 A typical	TIMTER S band, 18 or 20 Watt	2.8 A max.	2.5 A typical	TIMTER L/S band, 5 Watt	1.2 A max.	1.0 A typical	TIMTER L/S band, 10 Watt	2.2 A max.	1.8 A typical	TIMTER L/S band, 18 or 20 Watt	3.2 A max.	2.8 A typical	TIMTER S band, 25 Watt	3.2 A max.	2.9 A typical	TIMTER C band, 10 mWatt	0.30 A max.	0.25 A typical	TIMTER C band, 5 Watt	1.5 A max.	1.3 A typical	TIMTER C band, 10 Watt	2.4 A max.	1.9 A typical	TIMTER C band, 18 Watt	3.4 A max.	3.0 A typical	TIMTER L/C band and S/C band, 10 mWatt	0.30 A max.	0.25 A typical	TIMTER L/C band and S/C band, 10 Watt	2.2 A max.	2.0 A typical	TIMTER L/C band and S/C band, 18 Watt	3.5 A max.	3.2 A typical	TIMTER L/S/C band, 10 mWatt	0.45 A max.	0.40 A typical	TIMTER L/S/C band, 10 Watt	2.5 A max.	1.8 A typical
TIMTER L or S band, 10 mWatt	0.30 A max.	0.25 A typical																																																								
TIMTER L or S band, 5 Watt	1.0 A max.	0.85 A typical																																																								
TIMTER L or S band, 10 Watt (2in <sup>3</sup> packages)	1.4 A max.	1.1 A typical																																																								
TIMTER L or S band, 10 Watt (>2in <sup>3</sup> packages)	1.8 A max.	1.5 A typical																																																								
TIMTER L band, 18 or 20 Watt	3.2 A max.	2.8 A typical																																																								
TIMTER S band, 18 or 20 Watt	2.8 A max.	2.5 A typical																																																								
TIMTER L/S band, 5 Watt	1.2 A max.	1.0 A typical																																																								
TIMTER L/S band, 10 Watt	2.2 A max.	1.8 A typical																																																								
TIMTER L/S band, 18 or 20 Watt	3.2 A max.	2.8 A typical																																																								
TIMTER S band, 25 Watt	3.2 A max.	2.9 A typical																																																								
TIMTER C band, 10 mWatt	0.30 A max.	0.25 A typical																																																								
TIMTER C band, 5 Watt	1.5 A max.	1.3 A typical																																																								
TIMTER C band, 10 Watt	2.4 A max.	1.9 A typical																																																								
TIMTER C band, 18 Watt	3.4 A max.	3.0 A typical																																																								
TIMTER L/C band and S/C band, 10 mWatt	0.30 A max.	0.25 A typical																																																								
TIMTER L/C band and S/C band, 10 Watt	2.2 A max.	2.0 A typical																																																								
TIMTER L/C band and S/C band, 18 Watt	3.5 A max.	3.2 A typical																																																								
TIMTER L/S/C band, 10 mWatt	0.45 A max.	0.40 A typical																																																								
TIMTER L/S/C band, 10 Watt	2.5 A max.	1.8 A typical																																																								
Input voltage	Standard: +28 ± 4 VDC With optional wide voltage (WV option): +8.0 to +34 VDC for 10 mW, 1 W, 2 W models +12 to +34 VDC for 5 W model +21 to +34 VDC for 10 W, 20 W, and 25 W models Note: The WV option is not supported on 20 W or 25 W S band or 18 W L/C or S/C band transmitters.																																																									

Specifications subject to change without notice





## TIMTER™ TRANSMITTER SPECIFICATIONS

Characteristic	Specification																																															
Power reversal	Reverse voltage protection																																															
Serial Control interface	2 - RS-232 serial control interface T - TTL serial control interface 4 - RS-422 serial control interface 6 - RS-422, 120 ohms differential, even when unit is powered off																																															
Clock and Data signal interfaces (Serial data with separate synchronous clock) (Input impedances are only specified when unit is powered On, unless explicitly stated as being valid in the Off state.)	H - TTL (10K ohms to ground) T - TTL (75 ohms to ground) A - TTL selectable between 75 ohms to GND and 10k ohms to GND R - TIA/EIA-422 (RS-422) - 120 ohms differential B - TIA/EIA-422 (RS-422) - 120 ohms differential, even when unit powered off M - Dual mode selectable (TTL terminated 10k ohms to GND, RS-422 term 120 ohms diff.) D - Dual mode selectable (TTL terminated 75 ohms to GND, RS-422 term 120 ohms diff.) S - Tri-mode selectable (TTL term 75 ohms to GND, TTL term 10k ohms to GND, and RS-422 term 120 ohms differential) L - LVDS (Low Voltage Differential Signal)																																															
Carrier frequency tuning increment	0.5 MHz minimum resolution unless FO option is installed, then 1Hz minimum																																															
Carrier frequency accuracy	± 2.0 ppm over temperature ± 6.0 ppm, all causes, including aging over 5 years																																															
Randomizer	15-stage LFSR, per IRIG 106. Selectable for bypass or enable CCSDS randomizer available if extended LDPC (LD6 option) is installed and enabled																																															
<b>Environmental Section</b>																																																
Operating temperature	-40°C to +85°C (10 mW, 1 W, 2 W, 5 W, 10 W models) -40°C to +70°C (20 W and 25 W models)																																															
Storage temperature	-55°C to +100°C (all models)																																															
Operating humidity	0 to 95% (non-condensing)																																															
Altitude	Up to 100,000 ft.																																															
<b>Physical Section</b>																																																
Dimensions (For the latest information about your transmitter, visit the Quasonix website)	<table border="1" style="width: 100%; border-collapse: collapse;"> <thead> <tr> <th style="text-align: center;">TIMTER™ Package</th> <th style="text-align: center;">Volume</th> <th style="text-align: center;">Width</th> <th style="text-align: center;">Length</th> <th style="text-align: center;">Height</th> </tr> </thead> <tbody> <tr> <td>02XX</td> <td style="text-align: center;">1.992 in<sup>3</sup></td> <td style="text-align: center;">2.000"</td> <td style="text-align: center;">3.000"</td> <td style="text-align: center;">0.332"</td> </tr> <tr> <td>04XX</td> <td style="text-align: center;">4.200 in<sup>3</sup></td> <td style="text-align: center;">2.000"</td> <td style="text-align: center;">3.000"</td> <td style="text-align: center;">0.700"</td> </tr> <tr> <td>05XX</td> <td style="text-align: center;">4.800 in<sup>3</sup></td> <td style="text-align: center;">2.000"</td> <td style="text-align: center;">3.000"</td> <td style="text-align: center;">0.800"</td> </tr> <tr> <td rowspan="2">06XX</td> <td style="text-align: center;">6.072 in<sup>3</sup></td> <td style="text-align: center;">2.000"</td> <td style="text-align: center;">3.000"</td> <td style="text-align: center;">1.012"</td> </tr> <tr> <td style="text-align: center;">6.546 in<sup>3</sup></td> <td style="text-align: center;">2.000"</td> <td style="text-align: center;">3.000"</td> <td style="text-align: center;">1.091"</td> </tr> <tr> <td rowspan="2">07XX</td> <td style="text-align: center;">6.672 in<sup>3</sup></td> <td style="text-align: center;">2.000"</td> <td style="text-align: center;">3.000"</td> <td style="text-align: center;">1.112"</td> </tr> <tr> <td style="text-align: center;">7.590 in<sup>3</sup></td> <td style="text-align: center;">2.200"</td> <td style="text-align: center;">3.450"</td> <td style="text-align: center;">1.000"</td> </tr> <tr> <td rowspan="2">08XX</td> <td style="text-align: center;">8.418 in<sup>3</sup></td> <td style="text-align: center;">2.000"</td> <td style="text-align: center;">3.450"</td> <td style="text-align: center;">1.403"</td> </tr> <tr> <td style="text-align: center;">9.180 in<sup>3</sup></td> <td style="text-align: center;">2.000"</td> <td style="text-align: center;">3.000"</td> <td style="text-align: center;">1.530"</td> </tr> </tbody> </table>	TIMTER™ Package	Volume	Width	Length	Height	02XX	1.992 in <sup>3</sup>	2.000"	3.000"	0.332"	04XX	4.200 in <sup>3</sup>	2.000"	3.000"	0.700"	05XX	4.800 in <sup>3</sup>	2.000"	3.000"	0.800"	06XX	6.072 in <sup>3</sup>	2.000"	3.000"	1.012"	6.546 in <sup>3</sup>	2.000"	3.000"	1.091"	07XX	6.672 in <sup>3</sup>	2.000"	3.000"	1.112"	7.590 in <sup>3</sup>	2.200"	3.450"	1.000"	08XX	8.418 in <sup>3</sup>	2.000"	3.450"	1.403"	9.180 in <sup>3</sup>	2.000"	3.000"	1.530"
	TIMTER™ Package	Volume	Width	Length	Height																																											
	02XX	1.992 in <sup>3</sup>	2.000"	3.000"	0.332"																																											
	04XX	4.200 in <sup>3</sup>	2.000"	3.000"	0.700"																																											
	05XX	4.800 in <sup>3</sup>	2.000"	3.000"	0.800"																																											
	06XX	6.072 in <sup>3</sup>	2.000"	3.000"	1.012"																																											
		6.546 in <sup>3</sup>	2.000"	3.000"	1.091"																																											
	07XX	6.672 in <sup>3</sup>	2.000"	3.000"	1.112"																																											
		7.590 in <sup>3</sup>	2.200"	3.450"	1.000"																																											
	08XX	8.418 in <sup>3</sup>	2.000"	3.450"	1.403"																																											
9.180 in <sup>3</sup>		2.000"	3.000"	1.530"																																												
Vibration	19.6 G (RMS) random, 20 Hz to 2,000 Hz, 3 axes																																															
Shock	60 G (PK), 1/2 sine, 5 ms duration, 3 axes																																															
Acceleration	100 G, 3 axes																																															
Connector - RF	All TIMTER: SMA female																																															
Connector – Baseband / Primary	TIMTER: MDM-15 (male for TTL or female for RS-422 interface)																																															

Specifications subject to change without notice



## nanoTX™ TRANSMITTER SPECIFICATIONS

Characteristic	Specification
<b>Main Section</b>	
Modulation type	PCM/FM (ARTM Tier 0), SOQPSK-TG (ARTM Tier I), Multi-h CPM (ARTM Tier II), BPSK, QPSK, OQPSK, UQPSK
Carrier frequency tuning range (All nanoTX™ models)	2200.5 - 2300.5 MHz (Lower S band)      2200.5 - 2394.5 MHz (S band)
RF output power	nanoTX and nanoPuck:      1 W, 2 W, 5 W, and 10 W <i>Option DP:</i> Dual power, 64 settings, user selects one for "high" and one for "low", chosen via baseband connector pin <i>Option VP:</i> Variable power, 32 settings over approx. 24 dB range via PC (non-uniform, largest step approximately 1 dB)
Carrier frequency tuning increment	1 Hz
Carrier frequency accuracy	± 2.0 ppm over temperature ± 6.0 ppm, all causes, including aging over 5 years
Data (bit) rate, automatic rate adaptation	nanoTX, nanoPuck:      0.1-28 Mbps (0.05-14 Mbps for PCM/FM) nanoTX <i>option HR:</i> Extends upper limit to max of 46 Mbps (23 Mbps for PCM/FM) nanoTX <i>option LR:</i> Extends lower limit to min of 50 kbps (25 kbps for PCM/FM)
Input voltage	nanoTX, nanoPuck:              +28 ± 4 VDC Standard nanoTX, nanoPuck with <i>optional</i> wide voltage (WV option): +8.0 to +34 VDC for 1 Watt models +8.0 to +34 VDC for 2 Watt models +12 to +34 VDC for 5 Watt models +21 to +34 VDC for 10 Watt models
Input current @ +28 VDC	nanoTX, nanoPuck              1 Watt              450 mA max;      350 mA typical nanoTX, nanoPuck              2 Watt              570 mA max;      480 mA typical nanoTX, nanoPuck              5 Watt              1.0 A max;        800 mA typical nanoTX, nanoPuck*            8 or 10 Watt      1.3 A max;        1.1 A typical *8 or 10 Watt nanoPuck not available with GN option
Power reversal	Reverse voltage protection
Control interface	1 - LVTTTL serial control interface (nanoPuck) 2 - RS-232 serial control interface (nanoTX)
Signal interfaces	H - TTL 10k ohms to ground T - TTL 75 ohms to ground R - TIA/EIA-422 (RS-422) - 120 ohms differential B - TIA/EIA-422 (RS-422) - 120 ohms differential, even when unit powered off
Randomizer	15-stage LFSR, per IRIG 106. Selectable for bypass or enable CCSDS randomizer available if extended LDPC (LD6 option) is installed and enabled
<b>Environmental Section</b>	
Operating temperature	-40°C to +85°C (1 W, 2 W, 5 W, and 10 W nanoTX models; 10 W nanoPuck)
Storage temperature	-55°C to +100°C (all models)
Operating humidity	0 to 95% (non-condensing)
Altitude	Up to 100,000 ft.

Specifications subject to change without notice



## nanoTX™ TRANSMITTER SPECIFICATIONS

Characteristic	Specification
<b>Physical Section</b>	
Dimensions	nanoTX 01Ax packages: 1.275 in <sup>3</sup> , 1.250" (W) x 3.400" (L) x 0.300" (H) nanoPuck 01Px package: 1.280 in <sup>3</sup> , 2.300" (Dia) x 0.325" (H)
Vibration	19.6 G (RMS) random, 20 Hz to 2000 Hz, 3 axes
Shock	60 G (PK), 1/2 sine, 5 ms duration, 3 axes
Acceleration	100 G, 3 axes
Connector - RF	nanoTX (all packages): Female MMCX nanoPuck (all packages): Female MMCX
Connector – Baseband / Primary	nanoTX 01Ax package: Female 15 Pin or 21 Pin nano nanoPuck 01Px package: SAMTEC FTSH-108-04-F-D

## TIMTER™, nanoTX™, and nanoPuck™ PART NUMBERING

### Transmitter Part Numbering Example

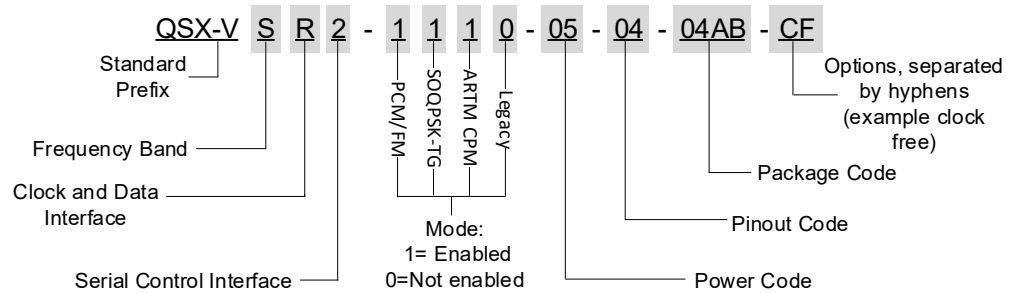

Power Code	Output Power
01	1-W
02	2-W
05	5-W
10	10-W
20	20-W
25	25-W

**Contact Quasonix for detailed descriptions of codes, packages, and options**

## SAMPLE nanoTX™ PACKAGES



nanoTX 01Ax



nanoPuck 01Px

## TIMTER™ OPTIONAL FEATURES

> AC	Automatic Carrier Wave Output	> LD	Forward Error Correction / Low Density Parity Chk
> AI	Auxiliary Input for digital data that is already pre-mod filtered	> LD6	Extended Low Density Parity Check (LDPC)
> AP	Adapter Plate (hardware accessory)	> LR	Low Bit Rate - Decreases default min bit rate to 50 kbps (25 kbps for Tier 0)
> BRx	Baud Rate	> MA	Below Lower S band, 2025.0 MHz to 2110.0 MHz (for Space operation and Space research apps)
> C7	Quasonix interpretation of IRIG 106-17	> MK	Randomizer Hardware Control (hardware option)
> CE	Convolutional Encoder (k=7 rate 1/2)	> MS	Modulation Scaling
> CF	Clock-free Baseband Interface	> P9	MDM-9 Accessory Board (hardware accessory)
> CG	Clock Generator Output to Baseband	> PF	Parallel Port Frequency Programming
> DP	Dual Power, 64 settings, user selects one for "high" and one for "low", chosen via baseband connector pin	> PM	Parallel Port Mode Selection
> EN	Ethernet Payload Capability	> PS	Hardware Preset (PS2, PS4, PS8, or PS16)
> FM	Allows the TIMTER™ to function as an analog FM transmitter	> RH	Recall Holdoff
> FO	Frequency Offset	> STDN	Supports Spacecraft Tracking and Data Network (PM/BPSK) mode
> GN	GPS Notch (lowers noise at L <sub>1</sub> and L <sub>2</sub> )	> SWBX	Switch Box (hardware accessory)
> HR	High Bit Rate - Increases default max bit rate to 46 Mbps (23 Mbps for Tier 0)	> VF	Variable FIFO Depth, controls transmitter latency
> ID	Internal Clock and Data can be saved as a power-up default	> VP	Variable power (31 settings, spanning 24 dB)
> LC	Low current in the RF Off state, < 10 mA (hwd opt)	> WV	Wide input voltage range

For additional information, contact Quasonix.

## nanoTX™ OPTIONAL FEATURES

> AC	Automatic Carrier Wave Output	> LC	Low current in the RF Off state, < 10 mA (hwd opt)
> BRx	Baud Rate	> LD	Forward Error Correction / Low Density Parity Check
> C7	Quasonix interpretation of IRIG 106-17	> LD6	Extended Low Density Parity Check (LDPC)
> CE	Convolutional Encoder (k=7 rate 1/2)	> LR	Low Bit Rate - Decreases default min bit rate to 50 kbps (25 kbps for Tier 0)
> CF	Clock-free Baseband Interface	> MS	Modulation Scaling
> DP	Dual Power, 64 settings, user selects one for "high" and one for "low", chosen via baseband connector pin	> PS	Hardware Preset (PS2, PS4, PS8, or PS16)
> FO	Frequency Offset	> STDN	Supports Spacecraft Tracking and Data Network (PM/BPSK) mode
> GN	GPS Notch (lowers noise at L <sub>1</sub> and L <sub>2</sub> )	> VF	Variable FIFO Depth controls transmitter latency
> HR	High Bit Rate - Increases default max bit rate to 46 Mbps (23 Mbps for Tier 0)	> VP	Variable power (31 settings, spanning 24 dB)
> ID	Internal Clock and Data can be saved as a power-up default	> WV	Wide input voltage range

For additional information, contact Quasonix.



## TRANSMITTER ACCESSORIES

- **Adapter Plate (P/N: QSX-AC-AP96)**

Adapts the 2" x 3" TIMTER™ transmitter footprint to a larger 2.5" x 3.5" mounting footprint

- **Fan-Cooled Heat Sink (P/N: QSX-AC-32-HS-12V)**

Heat sink with fan for TIMTER™ and nanoTX™ models. Includes power supply for North American operation. Refer to pages 20 and 23 for photos.



- **Transmitter-powered Heat Sink (P/N: QSX-AC-32-HS-28V-SP)**

Heat sink with integral fan. power supply, and temperature-controlled power on at +37°C. Draws power directly from a TIMTER™ transmitter. External power supply not needed

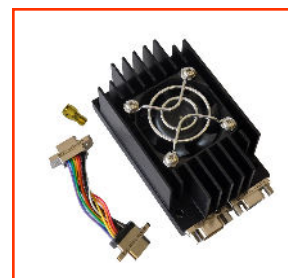

- **MDM-15 Connector and Pigtails (P/N: QSX-AC-MDM15-36-PIN or QSX-AC-MDM15-36-SOCK)**

Mating connector prewired with 36" non-terminated, color-coded pigtail cables for transmitter connections. Pin connector required for standard RS-422 transmitters, socket connector for standard TTL transmitters



- **MDM-15 Wiring Harness (P/N: QSX-AC-MDM15-HARNESS-PIN or QSX-MDM15-HARNESS-SOCK)**

Mating connector prewired and terminated with BNC connectors for clock and data, banana plugs for power and ground, and a DB-9 connector for serial control. Pin connector required for standard RS-422 transmitters, socket connector for standard TTL transmitters



- **2<sup>nd</sup> Generation Digital Frequency and Mode Switch Box (P/N: QSX-AC-DSWBX)**

Small aluminum digital switch box for use with all Quasonix transmitters equipped with the 9-pin parallel port. Provides frequency and mode programming capability. LED display supports modes 0-14 and five frequency digits. Channel selector for use with Quasonix Dual Transmitters.



- **USB to Serial Adapter (P/N: QSX-AC-USBSER-CONV)**

Converts USB interface to serial interface for controlling transmitters from a PC that does not have a DB-9 connector



# QUASONIX

## HEAT SINKS for MULTI-MODE TRANSMITTERS

Quasonix offers a number of heat sinks for use with TIMTER™ transmitters and nanoTX™ transmitters. The heat sink required for a particular transmitter depends heavily on the installation. Factors such as altitude, air temperature, air flow, and mass of the mounting surface all have a substantial impact on the flow of heat away from the transmitter.

It is important that the bottom surface (the face opposite the product label) be securely attached to a baseplate capable of dissipating the power produced by the transmitter model in use. This mounting baseplate must be flat, smooth, and clean.

Quasonix offers different types of integrated and add-on heat sinks, as described in this datasheet. Please contact Quasonix for heat sink recommendations for your particular TIMTER™ transmitter.

Regardless of the heat sink, Quasonix strongly suggests using a thermal pad, such as Q-Pad® II from Bergquist.



- **Fan-cooled Heat Sink**  
(P/N QSX-AC-32-HS-12V)

*The copper heat sink with fan is compatible with most TIMTER™ and nanoTX™ models. It includes a power supply for North American operation. For ground applications only.*



- **Transmitter-powered Heat Sink**  
(P/N QSX-AC-32-HS-28V-SP)

*This heat sink has an integral fan, power supply, and temperature-controlled power on at +37°C. Two MDM-15 connectors and a provided pigtail cable allow the heat sink to draw power **directly** from a TIMTER™ transmitter, **eliminating the need for a separate external power supply.***

*By regulating fan speed to compensate for changes in air pressure/density under high altitude conditions, Quasonix' transmitter-powered heat sink provides thermal protection for a variety of applications.*

*The male and female heat sink connectors, along with the dual-gender cable, enable connection to any TIMTER™ transmitter. An SMA extender is included to ensure convenient RF connector access.*



## FAN-COOLED HEAT SINK SPECIFICATIONS (QSX-AC-32-HS-12V)

Characteristic	Specification
<b>Overall</b>	
Dimension	*100 mm (L) x 75.6 mm (W) x 27 mm (H) (Manufacturer's specifications in metric units)
Weight	442 grams
<b>Fan Section</b>	
Bearing System	Dual ball bearing
CFM	10.48
Connector	5.5 x 2.5 mm
Lead Wire	UL1430 #26AWG
Noise Level	51 dBA
Power	7.2 W
Rated Voltage	12 VDC
Safety Approvals (Standard)	CE, UL
Size	75 mm x 75 mm x 15 mm
Speed	5500 rpm
Static Pressure	17.58 max mmH2O
<b>Heat Sink Section</b>	
Fin Pitch	1.5 mm
Fin Thickness	~0.45 mm
Material	Copper C1020
<b>Power Supply Section</b>	
Current Output	1A
Polarization	Positive Center
Power Output	12 W
Voltage Input	100V—240V ~50/60 Hz
Voltage Output	+12 VDC



Specifications subject to change without notice



## TRANSMITTER-POWERED HEAT SINK SPECIFICATIONS (Qsx-AC-32-HS-28V-SP)

Characteristic	Specification
<b>Overall</b>	
Current Draw	5 mA (idle); 140 mA (running)
Dimension	3.176" (L) x 2.000" (W) x 1.323" (H)
Voltage Input	28 V
Voltage Range	21 V — 34 V
Weight	156 grams
<b>Fan Section</b>	
Bearing System	Dual ball bearing
CFM	14.83
Material	Plastic (UL 94V-0)
Noise Level	41.5 dBA
Regulated Speed	11000 rpm
Static Pressure	15.26 max mmH2O
<b>Heat Sink Section</b>	
Fin Pitch	0.235"
Fin Thickness	0.05"
Material	6061-T6
Fin Height	0.940"
Number of Fins	9

Connection to transmitter with a female MDM-15



Connection to transmitter with a male MDM-15

**ATTENTION: Do not operate the transmitter without a proper heat sink. Failure to do so may lead to permanent damage to the unit and will void the warranty.** Overheating can occur in a matter of seconds when a transmitter is not properly heat-sinked. In absolutely no case should any type of stickers or labels be applied to the bottom surface of the transmitter.



**SAMPLE HEAT SINK APPLICATIONS**

**Fan-Cooled Heat Sink (P/N: QSX-AC-32-HS-12V)  
shown with mounted nanoTX™ and standard TIMTER™ transmitters**



**Transmitter-powered Heat Sink (P/N: QSX-AC-32-HS-28V-SP)  
shown with mounted TIMTER™ 04AB package and TIMTER™ 07AE package  
MDM-15 connector enables use with either gender on transmitters**

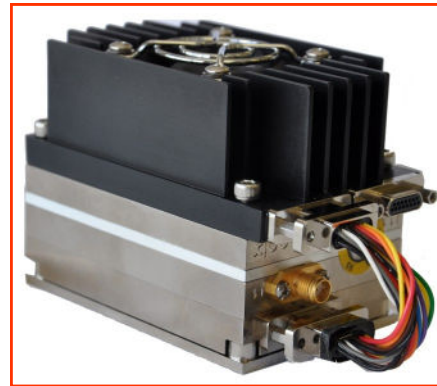
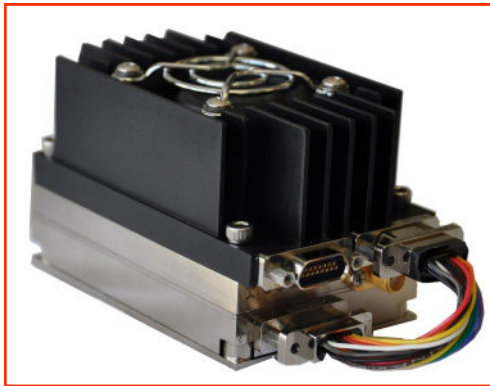

**Two Transmitter-powered Heat Sinks  
(P/N: QSX-AC-32-HS-28V-SP)  
shown with mounted TIMTER™ 24xx package  
MDM-15 connectors enable use with either  
gender on transmitters  
SMA extender(s) ensure convenient  
RF connector access**

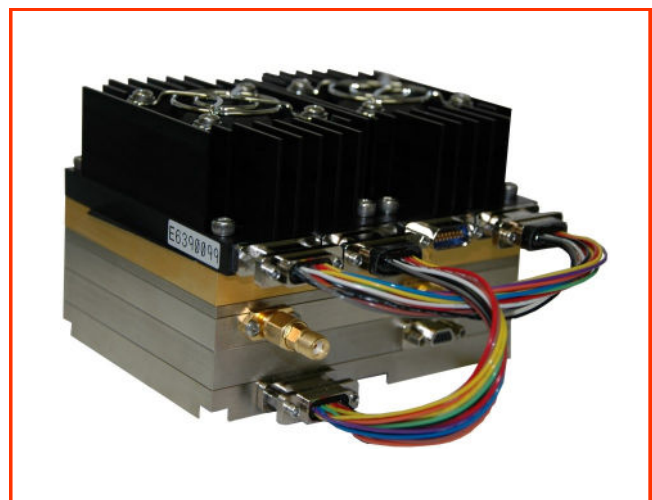

Adopted by the  
Range Commander's  
Council, IRIG 106-17,  
Appendix 2-D

## LOW DENSITY PARITY CHECK (LDPC) ERROR CORRECTION SYSTEM



RDMS™ Rack Mount Receivers



Side by Side Dual TIMTER™



TIMTER™



nanoTX™

The Low Density Parity Check (LDPC) Forward Error Correction mode is a *breakthrough* addition to Quasonix transmitters and receivers.

- **Improves Link Margin by 8.8 to 9.4 dB at BER = 1e-5**  
Link margin improvement is equivalent to nearly tripling the operating distance on your telemetry link

- **Adaptive Decoder**

Decoding performance is within 0.2 dB of theory

Iterative decoding is optimized to fully utilize available time, improving coding gain even further as the bit rate is reduced

- **Fully Integrated Forward Error Correction System**

Transmitter automatically synthesizes expanded over-the-air bit rate for encoded blocks and receiver seamlessly converts back to continuous output at the user bit rate

Operation is completely transparent to data devices

- **Robust Synchronization**

Reliable synchronization achieved as low as  $-4$  dB  $E_b/N_0$

- **Uses Spectrally Efficient SOQPSK Modulation**

Even with the LDPC coding overhead, bandwidth can be 22% —or even 34%—less than PCM/FM at the same payload bit rate; Payload bit rates up to 35 Mbps are supported

- **Simple ON / OFF Control**

Allows transmitter/receiver operation with or without correction

- **Tested on Several DoD Ranges**

**Already own Quasonix equipment?**

The LDPC mode can be retrofitted to most Quasonix transmitters and receivers. Contact Quasonix for details.

## LDPC FORWARD ERROR CORRECTION PERFORMANCE

### Performance Overview

Quasonix is the only vendor in the market offering LDPC encoding and decoding for serial streaming telemetry. This approach yields nearly triple the communications range, yet it can do so with 22%, or even 34%, less bandwidth than conventional PCM/FM.

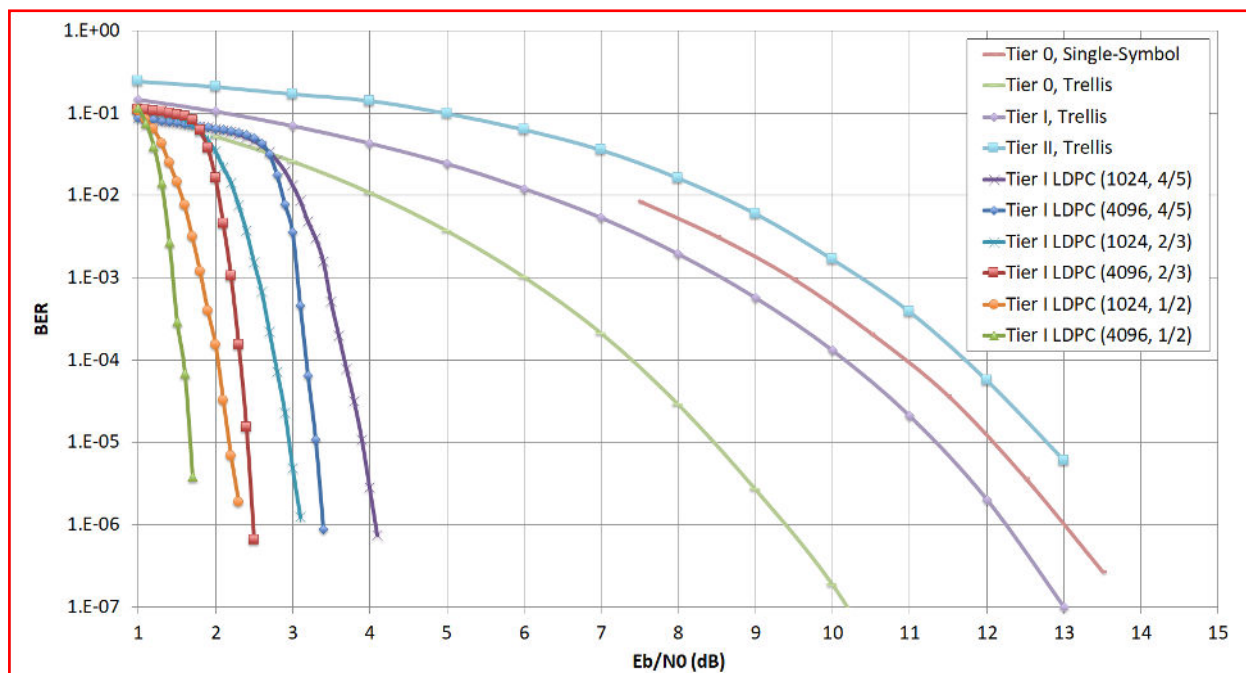

The IRIG standard calls out six variants of LDPC codes—all combinations of two different information block sizes ( $k=4096$  bits and  $k=1024$  bits) and three different code rates ( $r=1/2$ ,  $r=2/3$ , and  $r=4/5$ ). The larger block size offers better decoding performance in a static channel, but may work less well in a dynamic channel with fast fading or other impairments. Lower code rates also provide better decoding performance at the cost of increased occupied bandwidth.

Quasonix 3rd Generation RDMS™ Receivers offer all six block sizes/code rates. Contact Quasonix for transmitter offerings.

### Synchronization Threshold

The best coding gain in the world won't help if the telemetry link cannot maintain synchronization through extremely deep fades. Only Quasonix can consistently show synchronization at negative  $E_b/N_0$  values, and the LDPC subsystem is no exception. The ability to preserve bit count integrity at  $E_b/N_0$  as low as  $-6$  dB allows the user's crypto devices to stay synchronized under the most severe fading conditions, thereby eliminating the long data outages that occur when the crypto devices lose sync.

Not only does the LDPC subsystem maintain synchronization under highly adverse link conditions, but under worst-case link conditions the re-synchronization penalty is at most one LDPC code block.

Signal plus noise,  
synchronized at  
 $-3$  dB  $E_b/N_0$

Signal plus noise,  
error-free at  
 $+3$  dB  $E_b/N_0$

Strong signal,  
 $+35$  dB  $E_b/N_0$

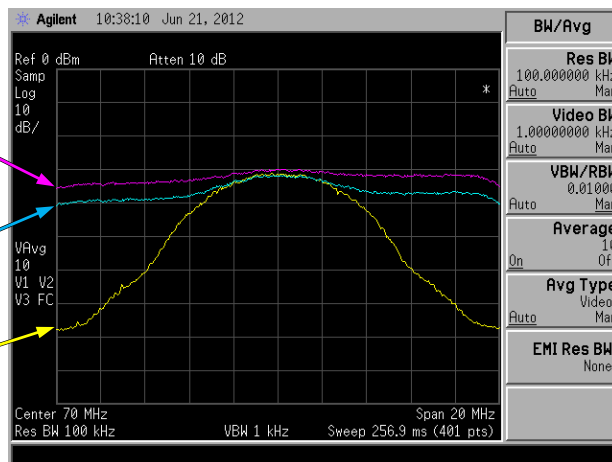

Receiver IF Output During 7 Mb/s  $k=4096$ ,  $r=2/3$  LDPC Operation



# QUASONIX

## ETHERNET VIA TELEMETRY SYSTEM

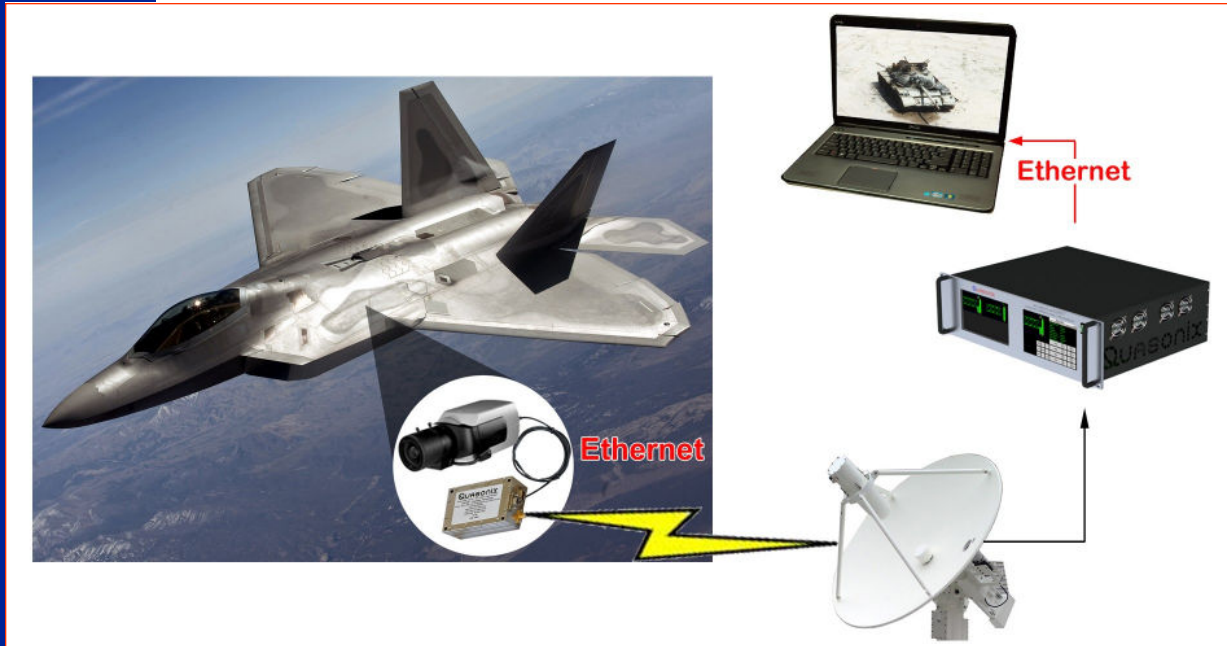

### Put Your Test Article on Your Ground Station LAN

Redefine the “Local” in Local Area Network. With the Quasonix Ethernet Via Telemetry (EVTM) system, your test article can be on your ground station LAN, just like any other computer or Ethernet appliance. With an Ethernet switch in your test article, you can connect cameras, Voice over IP, computers, etc. to your network on the ground.

- **High Speed Ethernet Traffic Over Telemetry Links**

*Ethernet telemetry data rates up to 40 Mbps using standard Ethernet protocols\*\**

- **Enables Ethernet Data Transmission for a Wide Variety of Applications**

*Multimedia streaming, data source selection, data source isolation and forwarding, source rate and coding control in reaction to channel impairments, network extension, Voice over IP (VoIP), COTS based Ethernet products such as Industrial Control Sensor Devices and data recorders*

- **Complete Telemetry System**

*An Ethernet solution package that includes an integrated Quasonix TIMTER™ Transmitter and a Quasonix Compact RDMS™ Telemetry Receiver for the downlink; The uplink includes a TIMTER™ Transmitter and a Quasonix Rack Mount RDMS™ Telemetry Receiver*

- **Supports all TCP/IP Packet Types**

*Streaming UDP packets, TCP connections, ICMP and SNMP messages are all passed over the air; Connection-oriented traffic requires a bidirectional link*

Specifications subject to change without notice

\*\* Bidirectional protocols require a bidirectional RF link.



### Advantages of the Quasonix Ethernet Via Telemetry Solution:

- **Time Division Duplex (TDD) or Frequency Division Duplex (FDD) Operation**
  - TDD synchronizes from GPS clock standard, or Master Slave mode
  - TDD switching modules can be added to existing FDD hardware
- **Network Extension**

Puts your test article on the same network as your ground equipment
- **Simple Interface Exposed to the End User**
  - Packets appearing on the Quasonix transmitter's Ethernet port are sent over the air
  - The same Ethernet packets are available at the receiver's Ethernet port
- **Optional COTS Devices Provide Tremendous Additional Capability**
  - An industrial computer module between the data sources and the transmitter allows sophisticated control of the downlink traffic
  - Ethernet enabled data recorders provide an interface for legacy sensors
- **Data Rates Up to 40 Mbps**

Fixed in advance for unidirectional links or controllable in flight with optional uplink

### Possible applications include:

- **Source Control/Selection**

Devices can be optionally enabled, disabled, and controlled either directly for Ethernet devices or via an Ethernet-enabled controller for devices without an Ethernet interface
- **Encryption**

The same security and encryption protocols available on the Internet become available over the telemetry link
- **Transmitter Power Cycling Controls**

For power-sensitive application, the ground controller can send messages to an air Ethernet-enabled controller to power the transmitter only when downlink data is required
- **Network Extension**

Isolated networks can be bridged over any terrain
- **Diagnostics and Health Monitoring**
  - The same status and error messages that maintain the Internet are available for monitoring and administration of the telemetry network
  - The Ground controller can monitor for transmitted network messages indicating link and link loss
  - For low security operations, GPS location data can be easily inserted into the downlink network traffic
  - Alarm, fault, and status messages can be multiplexed into the downlink stream using standard protocols (such as ICMP)
- **Data Isolation and Forwarding**

Source data can be partitioned by its network destination address permitting the ground station to forward traffic only to the appropriate destination
- **Control of COTS Camera Parameters Through the Ethernet Uplink**
  - Video resolution
  - Video compression
  - Camera direction

Contact Quasonix for more details

## QUASONIX EVTM AIRBORNE HARDWARE

### EVTM Node Controller

- Can be integrated with existing Quasonix receivers and transmitters
- Allows for TDD (Time Division Duplex) or FDD (Frequency Division Duplex) operation
- Smart router and data flow controls (IP addressable)
- With or without RF switch module



EVTM Node Controller

### Ethernet Enabled Receiver

- Built on proven RDMS receiver hardware
- Ethernet or serial data in same package



Ethernet Enabled RDMS™  
Compact Telemetry Receiver

### Ethernet Enabled Transmitter

- Available for most TIMTER transmitter models
- Ethernet or serial data in same package

Ethernet Enabled TIMTER™ Transmitter



### Airborne Encoder/Decoder

- Add Ethernet capabilities to existing airborne systems
- Flight ruggedized design
- Compatible with any transmitter



Airborne EVTM Encoder/Decoder

## QUASONIX EVTM GROUND STATION HARDWARE



1U Rack Mount EVTM Encoder/Decoder

### Rack Mount Encoder/Decoder

- One or two channels with separate Ethernet connections
- Each channel allows both uplink and downlink data
- Compatible with any receiver or transmitter

### Rack Mount Transceiver

- Fully functional ground station receiver
- Separate Ethernet connections for remote control and payload data



3U Rack Mount EVTM Transceiver

## EVTM NODE CONTROLLER PART NUMBERING

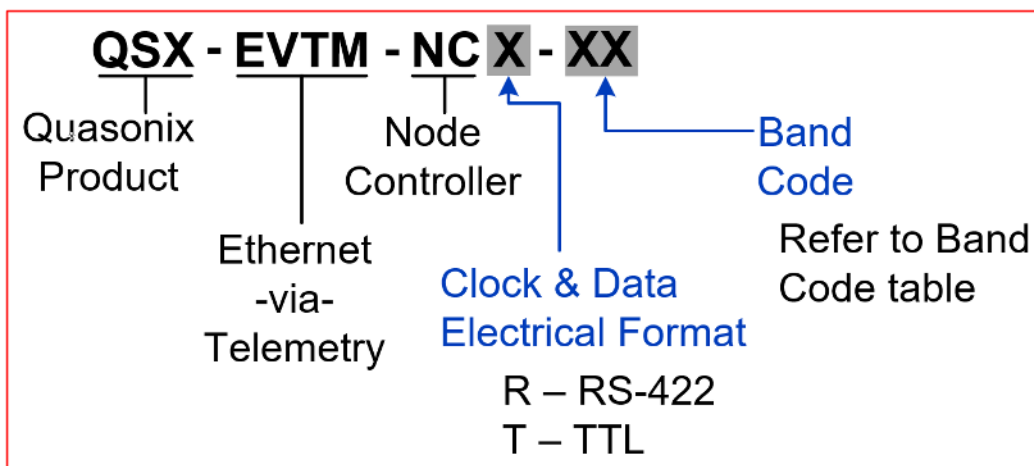

## BAND SELECTION (T/R SWITCH MODULE)

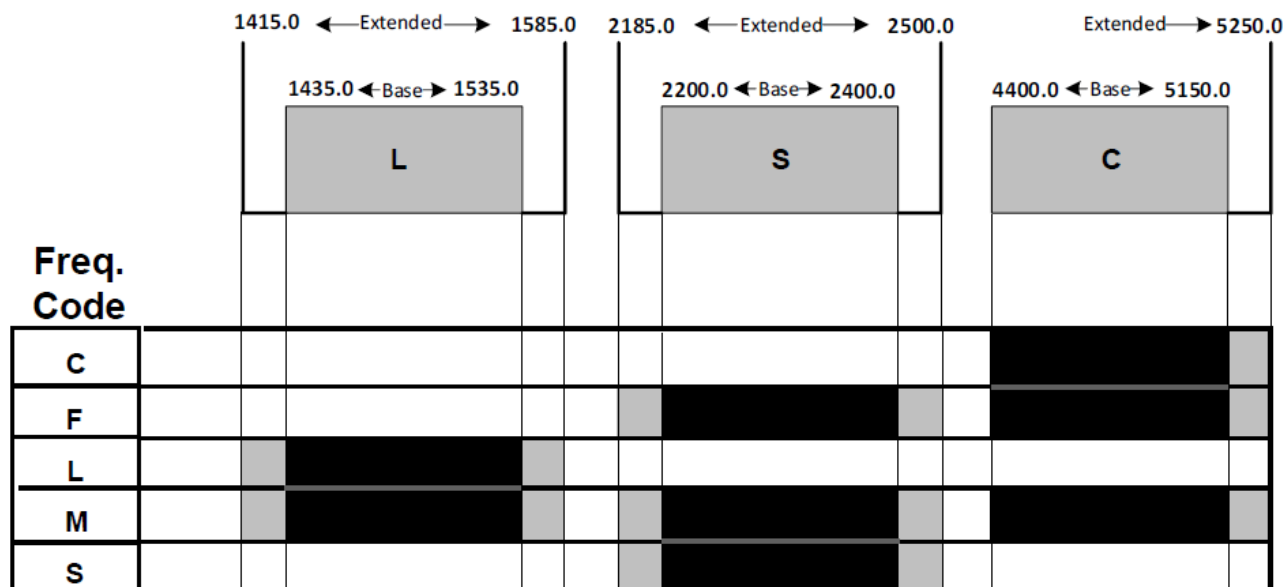

Legend:

- Frequency Gap
- Standard (Base) Frequency Range
- Extended Frequency Range  
(available by selecting Extended Tuning = 1 in part number)



View Online

# QUASONIX

## RACK-MOUNT RECEIVER ANALYZER

RA 3.0



- **Versatile Rack-Mount Enclosure with USB Interface**  
*Compact 1U 19" rack-mount chassis provides a single-box receiver analyzer solution, with USB plug and play; RA 3.0 extends capability and performance dramatically using existing fielded hardware*
- **Internal Signal Generators**  
*Includes two complete ARTM signal generators covering 200 MHz to 2500 MHz and 4.4 GHz to 5.25 GHz contiguously, with power levels from 0 dBm to -125 dBm*
- **Multipath Channel Emulator**  
*Provides 6-ray multipath emulation plus line-of-sight for static and dynamic multipath testing*
- **Internal Bit Error Rate Testers (BERTs)**  
*Eight bit error rate testers with integrated synchronization detection/measurement and bit rate counters*
- **Powerful User Interface Runs on any Windows PC**  
*Easy to use fully-configurable graphical user interface provides incredibly responsive control of all Receiver Analyzer functions and monitoring of all receiver status; make the interface as simple or as full-featured as needed*
- **Receiver Performance and Functionality Tests**  
*Comprehensive telemetry receiver test suite includes DQE/DQM verification, bit error rate, noise figure, receiver latency, acquisition time, acquisition threshold, combiner/BSS break frequency, and PCM/FM modulation index tests*
- **User-Definable Automated Tests**  
*Fully customizable test capability allows modifying standard tests or defining new test scenarios to provide almost limitless automatic receiver testing*
- **Dynamic Graphing and Logging of Automated Test Results**  
*Automated tests display results in interactive charts, in real time, and allow saving acquired data in several formats including customizable .CSV files for post-test processing and analysis*
- **DQM-Based Testing**  
*Use calibrated DQM rather than bit error rate measurements to decrease test time by orders of magnitude*





## RACK-MOUNT RECEIVER ANALYZER SPECIFICATIONS

Characteristic	Specification
<b>Signal Generator Section</b>	
RF Outputs	2, can be slaved
Power Level	0 dBm to -125 dBm, default range (set in 0.1 dB steps)
Output RF Frequency	200.0-2500.0 MHz, tunable in 1 kHz steps 4400.0-5250.0 MHz, tunable in 1 kHz steps
Modulation Formats	PCM/FM, SOQPSK, MHCPM, Carrier, BPSK, QPSK, OQPSK, AQPSK, UQPSK, STC
Bit Rates	0.001 Mbps to 46 Mbps (mode dependent)
Coding Options	Convolutional, Reed-Solomon, or LDPC (per IRIG 106-22 Appendix 2-D) IRIG and CCSDS randomization NRZ-L/M/S, BIΦ-L/M/S, RZ, DM-M/S, M2-M/S Basic PCM framing (sync pattern 16 to 33 bits, minor frame up to 16384 bits, major frame up to 256 words, with subframe ID insertion)
Generator Functions	Modulation index scaling Multipath fading (synchronized out-of-phase between RF channels) Multi-ray multipath channel simulation Calibrated additive white Gaussian noise
Clock and Data In/Out	TTL (BNC) Patterns: Mark (all 1s), Space (all 0s), ALT01, PN6, PN9, PN11, PN15, PN17, PN20, PN23, PN31, USER (2 to 32 bits)
<b>Receiver Input/Status Output Section</b>	
Clock and Data In	TTL (BNC) Supports up to eight (8) clock and data input pairs from receivers, demodulators, etc.
Input Codes	NRZ-L
Lock Detector Out	TTL (HDB-15)
RF On/Off Control Out	TTL (HDB-15)
<b>Environmental Section</b>	
Operating Temperature	0°C to +50°C
Storage Temperature	0°C to +70°C
Operating Humidity	0 to 95% (non-condensing)
Altitude	Up to 30,000 ft.
<b>Physical Section</b>	
Size	1U rack-mount chassis; 19" wide, 1.75" tall, 14-5/16" rack depth, 15-11/16" overall depth
Weight	12.0 lbs.
Connectors – per RF Channel	RF Out: N female I Clock, Q Clock, I Data, Q Data In: BNC female Combiner/BSS I Clock, Q Clock, I Data, Q Data In: BNC female Status Out: DB-15 High Density female
Connectors – per Chassis	TX Clock/Data In/Out: BNC female; USB-B for remote controlled user interface; AC power in
Power	25W @ 120 VAC

Specifications subject to change without notice



# RECEIVER ANALYZER USER INTERFACE

From basic functionality...

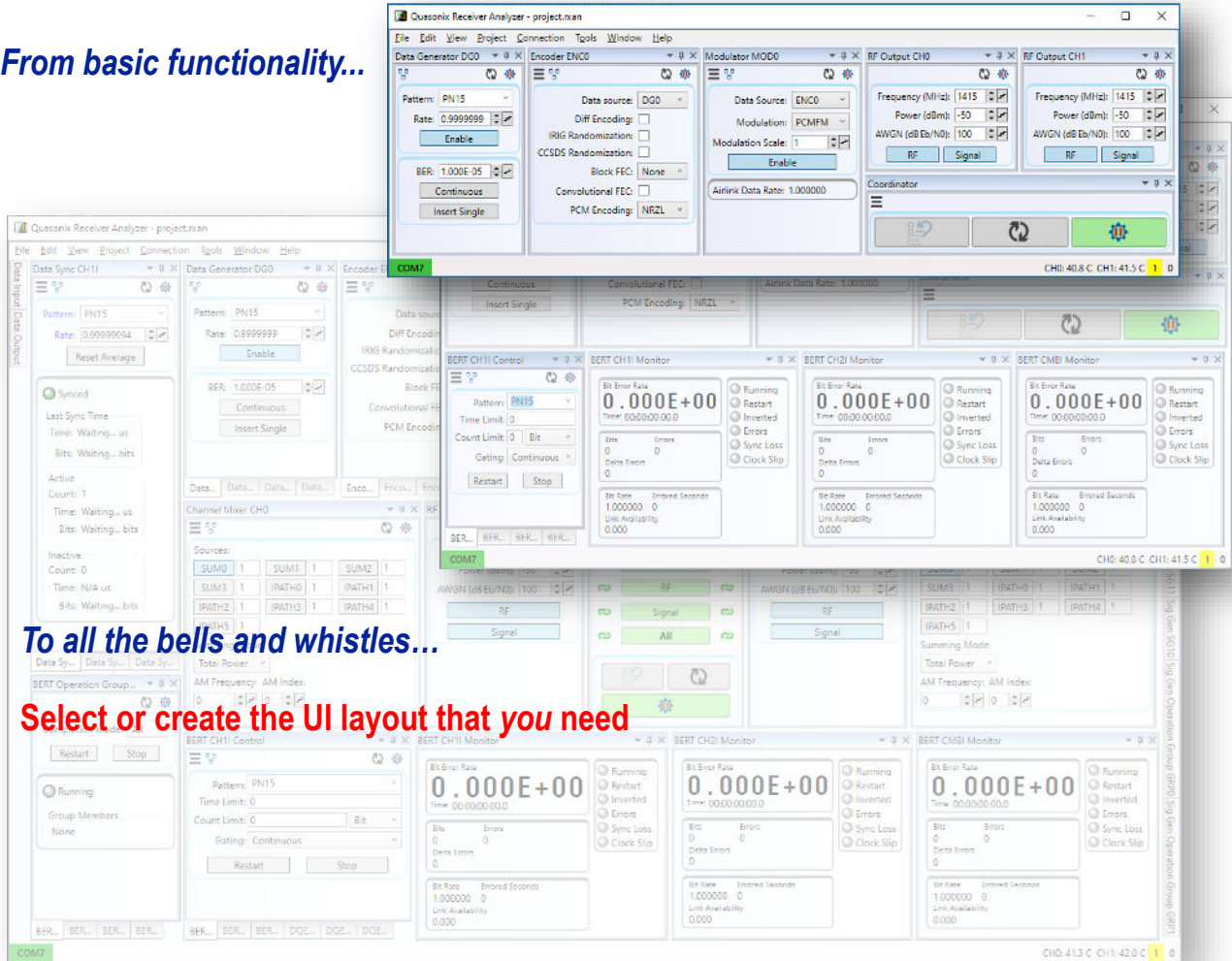

To all the bells and whistles...

Select or create the UI layout that you need

## Features

- ⇒ User configurable layout with primary window and optional floating windows
- ⇒ Responsive control and status saves time and frustration
- ⇒ Easily save and load projects (settings plus layout), layouts, measurement scripts, and test results
- ⇒ Measurement editor to modify standard automated tests and create new ones
- ⇒ Measurement results displayed in configurable, interactive, real time graphs, which can be saved as graphics files and restored from saved results files
- ⇒ Real-time status for all modules, including Modulator airlink data rate; DQE frame lock, frame count, estimated bit error probability (BEP), BEP bits, and BEP errors; and BERT bit error rate, elapsed time, bit count, error count, bit rate, errored seconds, and link availability measurements, plus data inversion, bit error, sync loss, and clock slip indicators for each channel
- ⇒ BERT continuous, single, and repeat test modes, with configurable first- or last-to-finish termination across multiple channels

## System Requirements

- ⇒ Windows 10 or newer

## RACK-MOUNT RECEIVER ANALYZER REAR PANEL LAYOUT



[www.quasonix.com](http://www.quasonix.com)

© 2022 Quasonix, Inc.



## RECEIVER ANALYZER PERFORMANCE

The Receiver Analyzer makes receiver characterization fast and easy. Automated testing allows precise measurement over many parameters and rapid acquisition of extremely large data sets. Saved data files facilitate result aggregation, analysis, presentation, and archival. From basic bit error rate performance to dynamic signal handling, such as acquisition time and combiner break frequency, the Receiver Analyzer will truly show how your receivers measure up. After you've calibrated receiver DQM, you can use estimated bit error probability in place of measured bit error rate to accelerate many performance tests by 100x or more.

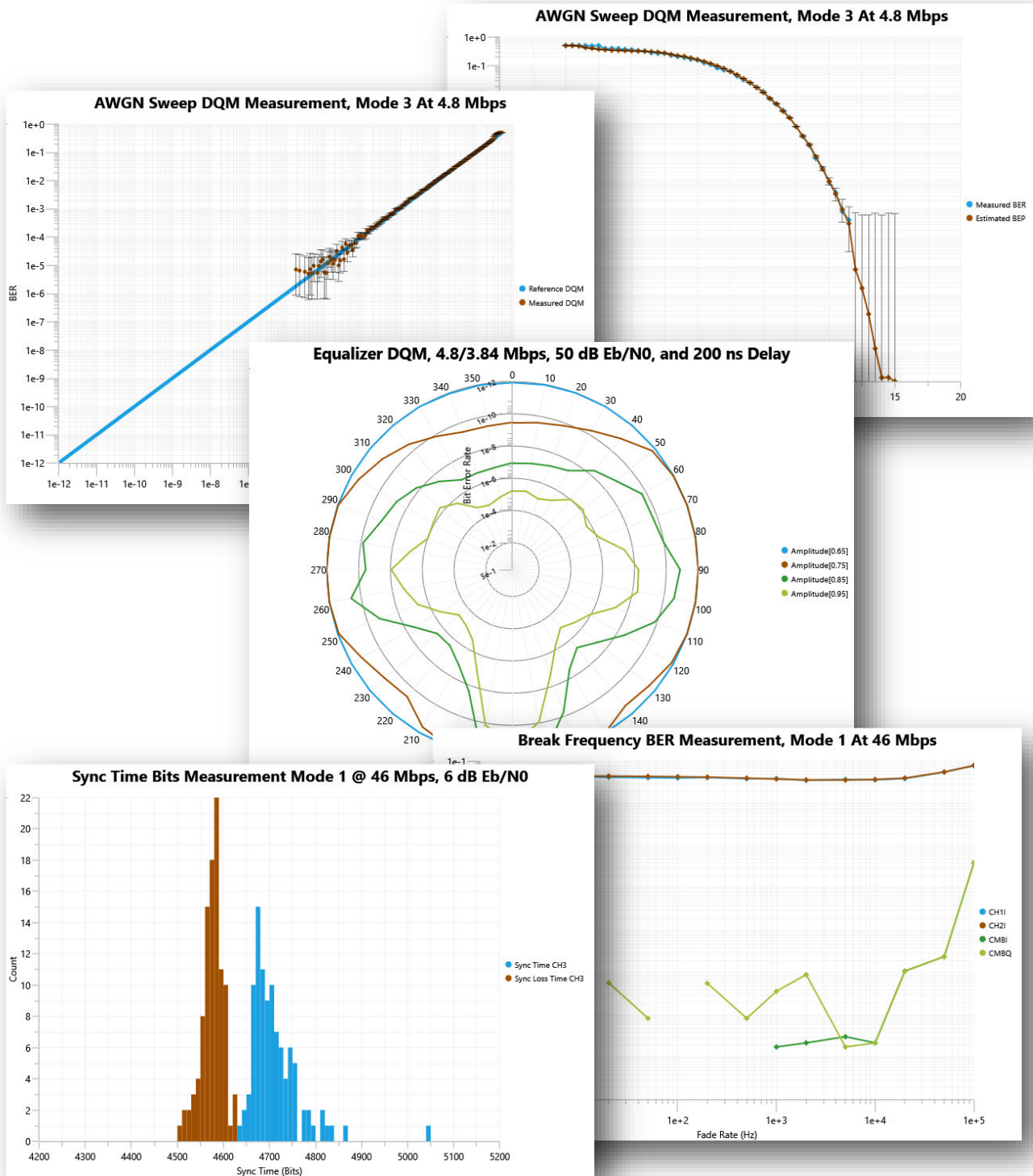



With razor-sharp focus on the aeronautical telemetry market and a team rich in talent, experience, and sheer determination, Quasonix is able to consistently design, develop and manufacture *what our customers regard as market-leading telemetry products.*

Quasonix is...*Reinventing Telemetry™*



Ivan Cholakov/Shutterstock.com



Photo Courtesy of SPACEX



**Galactic Headquarters**  
6025 Schumacher Park Drive  
West Chester, OH 45069  
(513) 942-1287  
info@quasonix.com

**Antenna Division**  
353 Science Drive  
Moorpark, CA 93021  
(805) 530-0014  
antennas@quasonix.com

[www.quasonix.com](http://www.quasonix.com)

QSX-CATALOG-220113

**Instrumentation  
Devices** 

Instrumentation Devices Srl  
Via Acquanera 29 - 22100 COMO (Italy)  
ph +39 031 525 391- fax +39 031 507 984  
info@instrumentation.it - [www.instrumentation.it](http://www.instrumentation.it)